

VC-A50PN PTZ Video Camera

User Manual - English

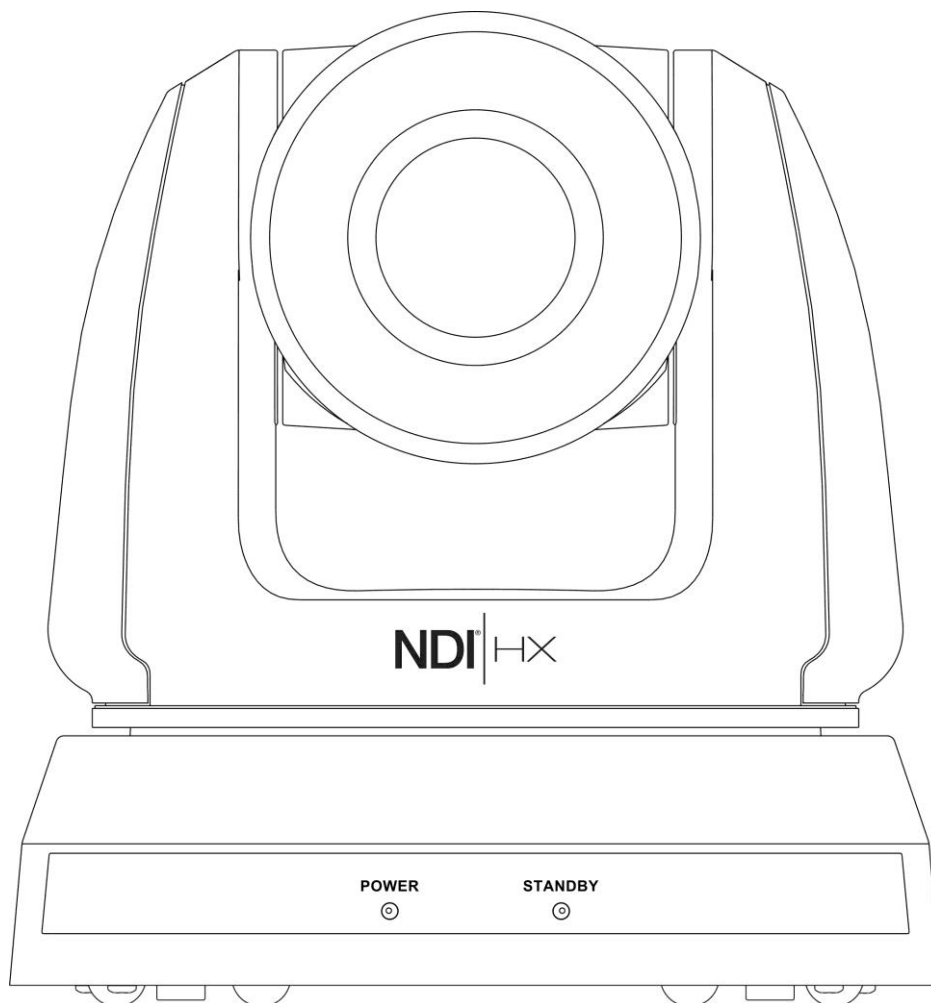

[Important]

To download the latest version of Quick Start Guide, multilingual user manual, software, or driver, etc., please visit Lumens
<https://www.MyLumens.com/support>

NDI® is a registered trademark of Vizrt Group

Table of Contents

Copyright Information	2
Chapter 1 Safety Instructions	3
Chapter 2 Package Contents	4
Chapter 3 Product Overview	5
3.1 Overview	5
3.2 Description of LED indicator.....	5
Chapter 4 Instruction for installation	6
4.1 Preparation before installation	6
4.2 Instruction for installation	6
4.3 Connecting devices	12
Chapter 5 Remote Control and Setting Menu	16
5.1 Functions of remote control.....	16
5.2 Setting Menu	17
Chapter 6 Descriptions of Major Functions	23
6.1 I would like to switch to VC-A50PN.....	23
6.2 I would like to save the current lens position data	23
6.3 I would like to clear the saved position data	23
6.4 I would like to turn on the back light compensation function.....	23
6.5 I would like to adjust the shooting angle of the lens	23
6.6 I would like to zoom in/out images	23
6.7 I would like to adjust the focal length	23
6.8 I would like to adjust the AF speed	23
6.9 I would like to set the image mode.....	24
6.10 I would like to freeze images.....	24
6.11 I would like to rotate the image	24
6.12 I would like to change the camera direction.....	24
6.13 I would like to display the current status	24
6.14 I would like to reset to the default value.....	24
Chapter 7 Network Function Settings Description	25
7.1 Web System Requirements	25
7.2 Online IP Camera.....	25
7.3 Web Page Function Description.....	27
Chapter 8 DIP switch setting	35
8.1 DIP SWITCH	35
8.2 RS-422 Connection.....	36
Chapter 9 Troubleshooting	38
Supplier's Declaration of Conformity 47 CFR § 2.1077 Compliance Information.....	39

Copyright Information

Copyrights © Lumens Digital Optics Inc. All rights reserved.

Lumens is a trademark that is currently being registered by Lumens Digital Optics Inc.

Copying, reproducing or transmitting this file is not allowed if a license is not provided by Lumens Digital Optics Inc. unless copying this file is for the purpose of backup after purchasing this product.

In order to keep improving the product, Lumens Digital Optics Inc. hereby reserves the right to make changes to product specifications without prior notice. The information in this file is subject to change without prior notice.

To fully explain or describe how this product should be used, this manual may refer to names of other products or companies without any intention of infringement.

Disclaimer of warranties: Lumens Digital Optics Inc. is neither responsible for any possible technological, editorial errors or omissions, nor responsible for any incidental or related damages arising from providing this file, using, or operating this product.

Limitations, Restrictions, on Licensee

Licensee shall not provide any terms in its End User License Agreement for the Enabling Firmware that it has with the End User, or otherwise take any action, inconsistent with the rights of NewTek set forth in this agreement. Licensee shall not interfere with, void, or otherwise make ineffective, any term of the NewTek NDI®|HX End User License Agreement ("NDI®|HX EULA") that is distributed with the NDI®|HX software by NewTek. The NewTek NDI®|HX EULA may be updated and modified for End Users downloading the NDI®|HX software in the future, at NewTek's sole discretion. NDI®|HX EULA also refers to any modifications that are made pursuant to the modification terms therein. Any direct or indirect distribution of the Enabling Firmware by Licensee, and any Upgrade Enabled Product, shall be under the terms of an End User License Agreement containing terms that are not inconsistent with the rights of NewTek hereunder, and shall include an anti-reverse engineering requirement applicable to the End User to prevent the End User from reverse engineering, disassembling, or recompiling, or attempting to do any of the foregoing, with the Enabling Firmware, the NDI®|HX Software and/or the interoperability between the two, in whole or in part.

Chapter 1 Safety Instructions

Always follow these safety instructions when setting up and using the Document Camera:

1 Operation

- 1.1 Please use the product in the recommended operating environment, away from water or source of heat
- 1.2 Do not place the product on a tilted or unstable trolley, stand or table.
- 1.3 Please clean the dust on the power plug prior to usage. Do not insert the product's power plug into a multiplug to prevent sparks or a fire.
- 1.4 Do not block the slots and openings in the case of the product. They provide ventilation and prevent the product from overheating.
- 1.5 Do not open or remove covers, otherwise it may expose you to dangerous voltages and other hazards. Refer all servicing to licensed service personnel.
- 1.6 Unplug this product from the wall outlet and refer servicing to licensed service personnel when the following situations happen:
 - If the power cords are damaged or frayed.
 - If liquid is spilled into the HD Camera or the HD Camera has been exposed to rain or water.

2 Installation

- 2.1 For security considerations, please make sure the standard hanging rack you bought is in line with UL or CE safety approbations and installed by technician personnel approved by agents.

3 Storage

- 3.1 Do not place the product where the cord can be stepped on as this may result in fraying or damage to the lead or the plug.
- 3.2 Unplug the product during thunderstorms or if it is not going to be used for an extended period.
- 3.3 Do not place the product or accessories on top of vibrating equipment or heated objects.



4 Cleaning

- 4.1 Disconnect all the cables prior to cleaning and wipe the surface with a dry cloth. Do not use alcohol or volatile solvents for cleaning.

5 Batteries (for products or accessories with batteries)

- 5.1 When replacing batteries, please only use similar or the same type of batteries.
- 5.2 When disposing of batteries or products, please adhere to the relevant instructions in your country or region for disposing of batteries or products.

■ Precautions

	This symbol indicates that this equipment may contain dangerous voltage which could cause electric shock. Do not remove the cover (or back). No user-serviceable parts inside. Refer servicing to licensed service personnel.		This symbol indicates that there are important operating and maintenance instructions in this User Manual with this unit.
---	---	---	---

■ FCC Warning

This equipment has been tested and found to comply with the limits for a Class A digital device, pursuant to part 15 of the FCC Rules. These limits are designed to provide reasonable protection against harmful interference when the equipment is operated in a commercial environment.

Notice :

The changes or modifications not expressly approved by the party responsible for compliance could void the user's authority to operate the equipment.

■ IC Warning

This digital apparatus does not exceed the Class A limits for radio noise emissions from digital apparatus as set out in the interference-causing equipment standard entitled "Digital Apparatus," ICES-003 of Industry Canada.

Cet appareil numérique respecte les limites de bruits radioélectriques applicables aux appareils numériques de Classe A prescrites dans la norme sur le matériel brouilleur: "Appareils Numériques," NMB-003 édictée par l'Industrie.

■ EN55032 (CE Radiation) Warning

Operation of this equipment in a residential environment could cause radio interference.

Chapter 2 Package Contents

VC-A50PN



Instruction for installation



Remote Control



Power Cord

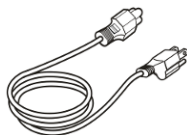

Appearance may vary depending on country/region

Power Adapter

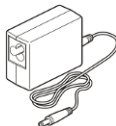

RS-422 Connector

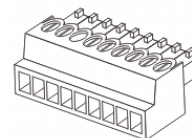

Metal Plate A

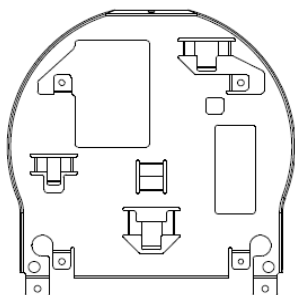

Metal Plate B

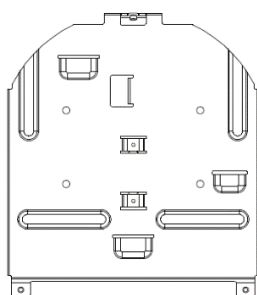

M3 Screws

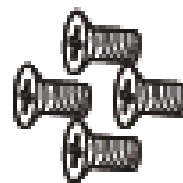

silver x 8, black x 2

Chapter 3 Product Overview

3.1 Overview

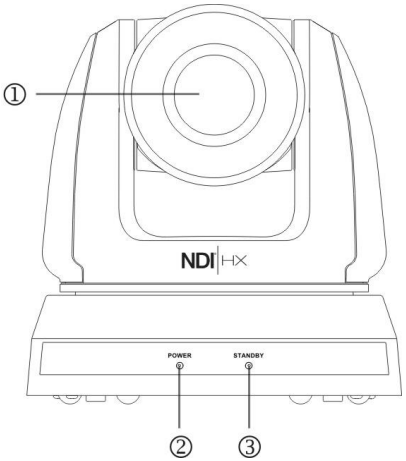
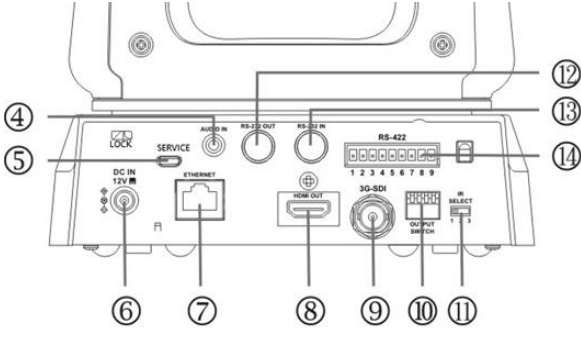
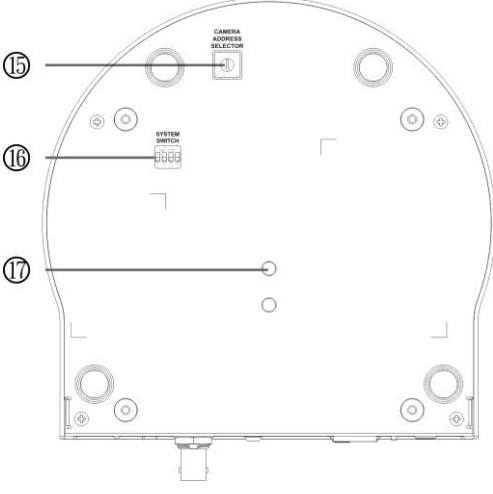
<p>Front View</p> 	<ol style="list-style-type: none"> 1. Camera lens 2. Power LED indicator 3. Standby LED indicator 4. Audio In 5. USB port (for FW update)
<p>Back View</p> 	<ol style="list-style-type: none"> 6. Power input 7. NDI HX / Network port (supporting IEEE 802.3at PoE+ power) 8. HDMI Output 9. 3G-SDI 10. OUTPUT Switch
<p>Bottom</p> 	<ol style="list-style-type: none"> 11. IR SELECT 12. RS-232 output 13. RS-232 input 14. RS-422 Connection 15. Camera Address Selectors 16. SYSTEM Switch 17. Tripod lock hole

3.2 Description of LED indicator

Status	Power	Standby
Startup in progress	Green light	Orange light
In use	Green light	No indicator
In standby mode	No indicator	Orange light
Tally mode	Red light	Red light

Chapter 4 Instruction for installation

4.1 Preparation before installation

Installation and connection of VC-A50PN HD camera requires special skills. To install by yourself, please follow necessary steps, ensure steady and tight installation of the device, and pay attention to your safety to avoid any accident.

- 4.1.1 **Ensure the safety of the installation environment. Please do not install the device on unstable ceiling or in a place where the device is in danger of falling to avoid any accident.**
- 4.1.2 **Please check whether accessories in the box are complete or not. Please contact the supplier for any shortage, and make sure to keep the accessories in the box intact.**
- 4.1.3 **Please choose a proper place for installation of VC-A50PN in advance. Please determine an installation place according to the following requirements**
 - 4.1.1.1 Confirm the position for the object to be captured.
 - 4.1.1.2 Confirm whether the VC-A50PN is set at a proper distance from other light sources.

4.2 Instruction for installation

4.2.1 I would like to install VC-A50PN on the desk

4.2.1.1 Precautions for installation

- ◆ Please install the machine on a flat desk
- ◆ Do not grab the camera head by hand when handling the device
- ◆ Do not rotate the camera head by hand. Improper rotation may result in breakdown of the camera

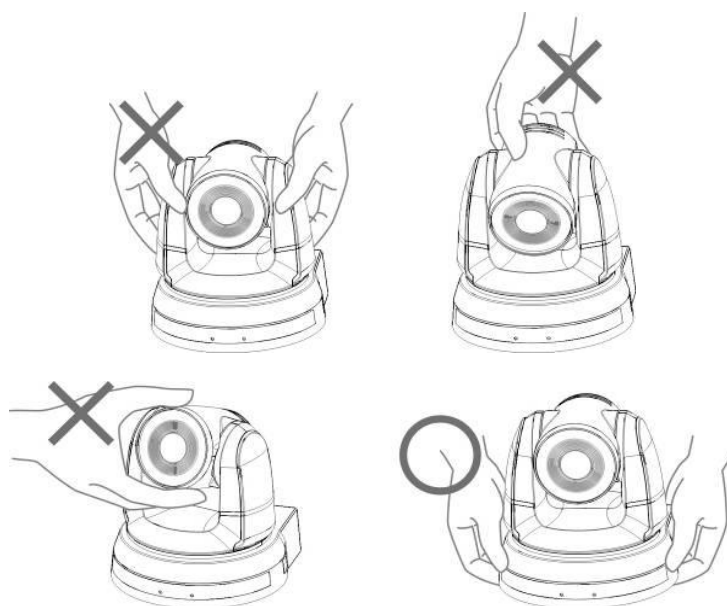

4.2.1.2 Installation steps

1. Please adjust DIP switch at first prior to installation

<Remark> Please refer to [Chapter 8 DIP Switch Setting](#) for the relevant descriptions on DIP switch.

2. Place the camera on a flat desk directly to ensure the normal vertical and horizontal operation of the machine

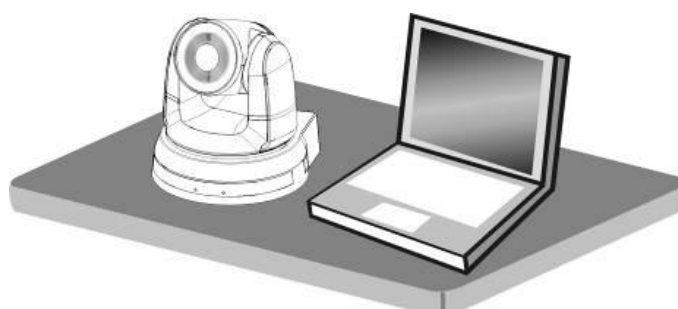

4.2.2 I would like to install VC-A50PN on the ceiling

4.2.2.1 Prepare for the parts and equipment required during the installation

1. Accessories of VC-A50PN in the box (metal plates A,B, M3 screw silver x 8, black x 2)
2. Screw for locking on ceiling mounted hanger x 4
3. Drilling machine, screw driver, ladder

4.2.2.2 Camera Size

Length x Width x Height : 174 x 186.2 x 185.5 mm

Weight : 1.8 Kg

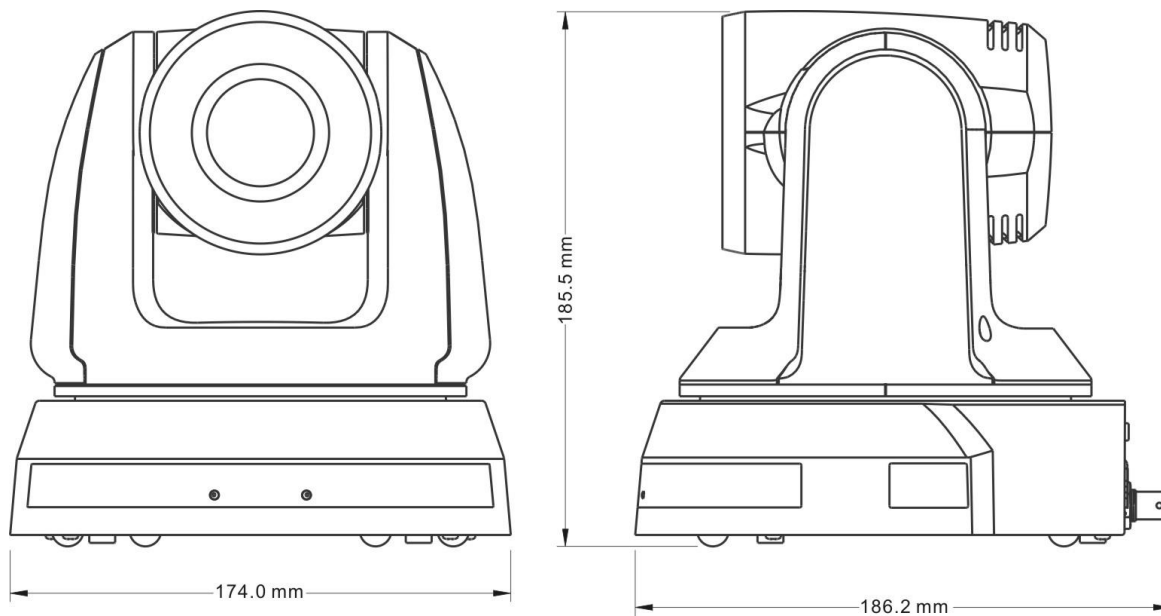

4.2.2.3 Max. rotation dimension of camera

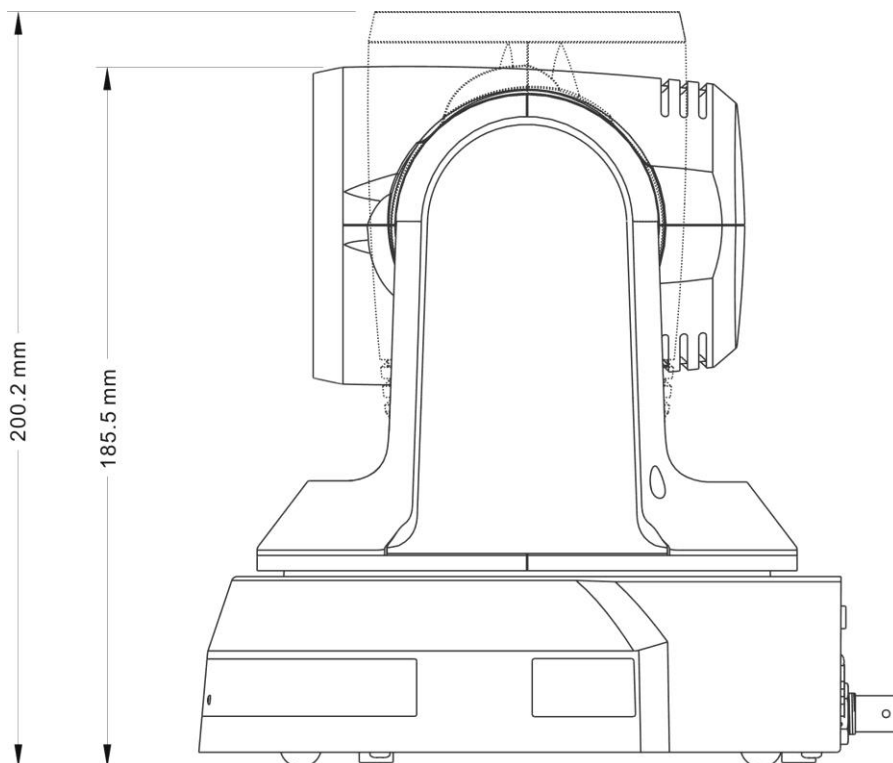

4.2.2.4 Size Diagram

1. Metal plate A - machine side

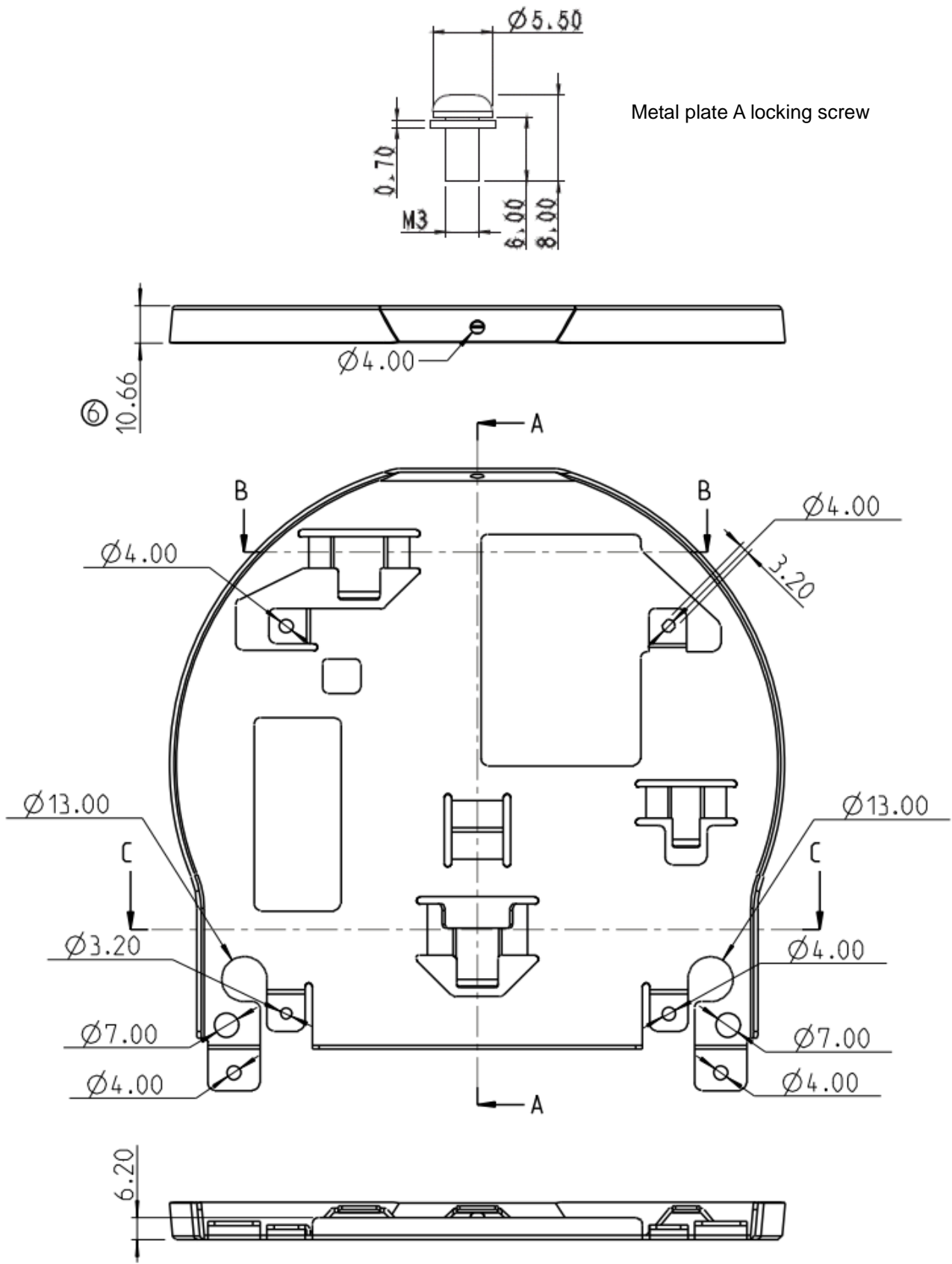

Metal plate A locking screw

Metal plate A - machine side

2. Metal plate B - ceiling side

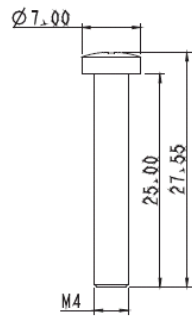

Metal plate B locking screw

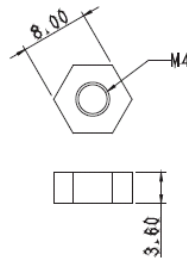

Metal plate B locking bolt

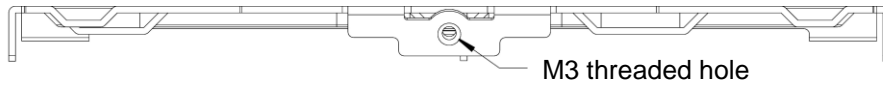

M3 threaded hole

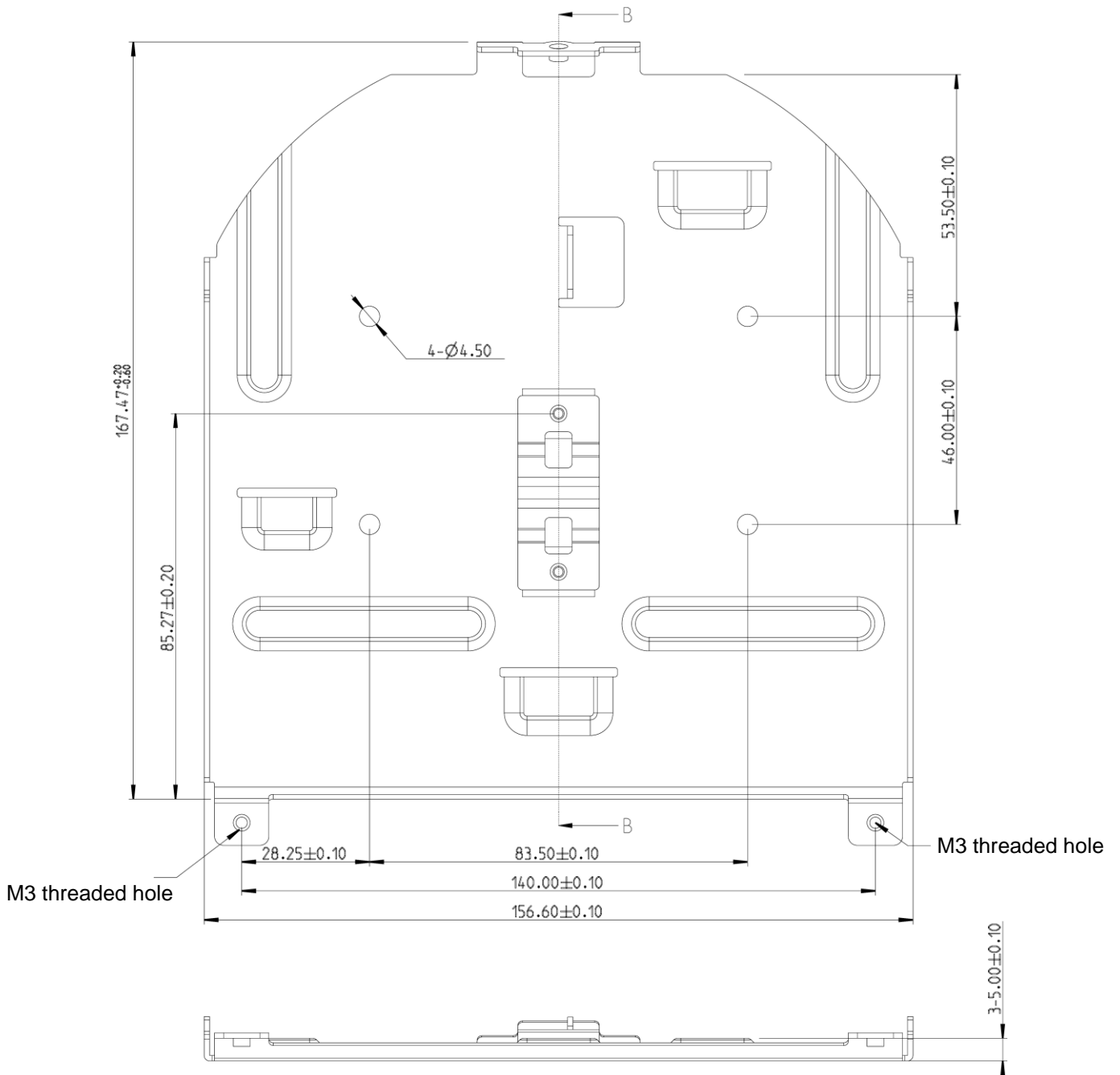

Metal plate B - ceiling side

3. Bottom of machine

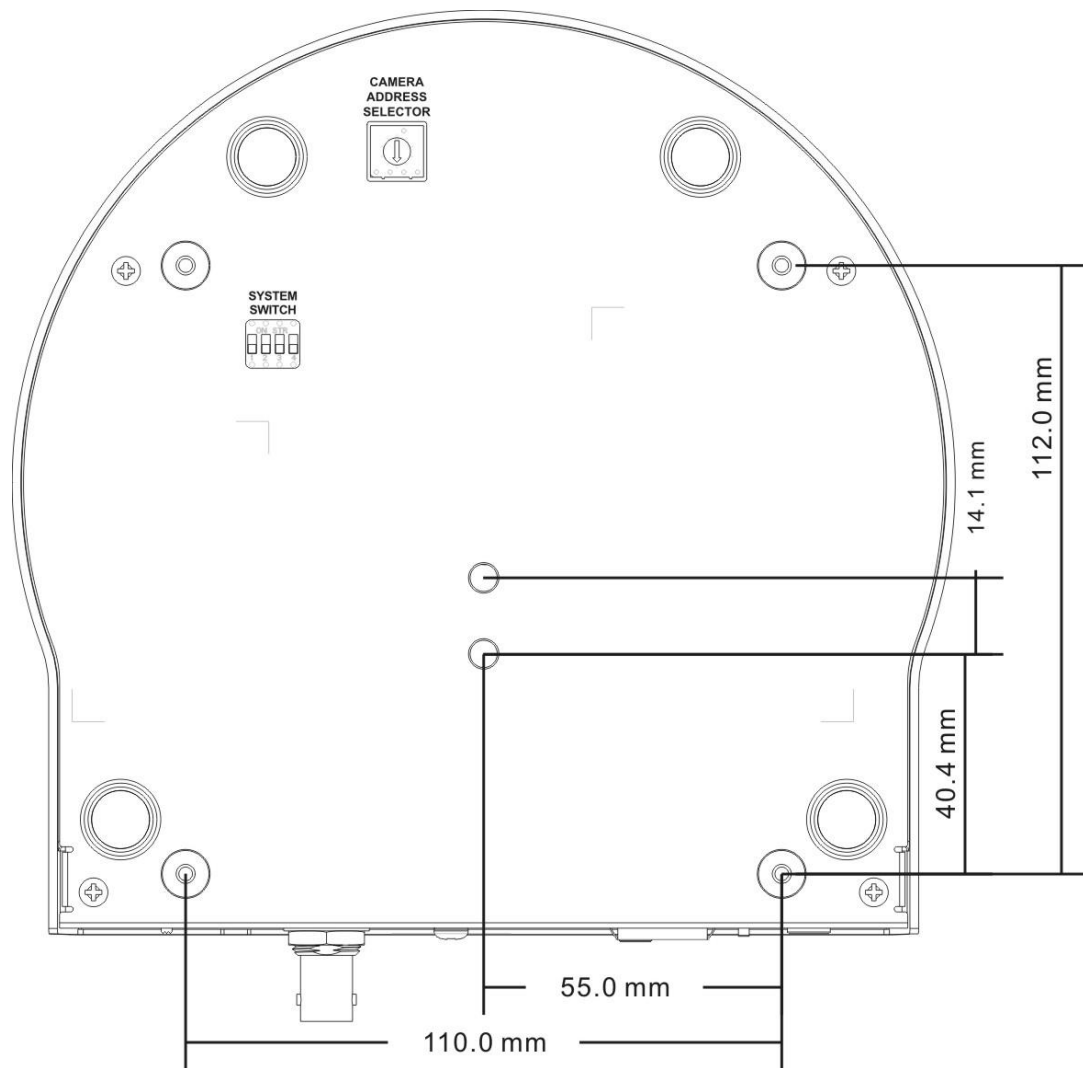

4.2.2.5 Precautions for installation

1. Before installation, please confirm the orientation of the machine relative to the object to be captured
2. It is recommended that the machine should be set at a distance of more than 1 meter away from the object to be captured. Please adjust for a best distance according to the magnification of the lens

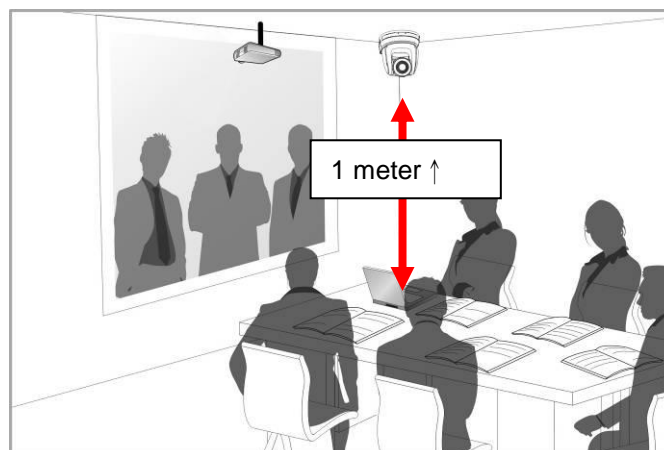

3. The machine (including metal plates) is weighed at about 2.5 kg. If it is to be installed on the ceiling, please use the hanger that has obtained UL security approval to prevent the machine from falling down.
4. Please check whether the camera is installed securely on a regular basis

4.2.2.6 Installation steps

1. Please adjust resolution on DIP switch at first

<Remark> Please refer to [Chapter 8 DIP Switch Setting](#) for the relevant descriptions on DIP switch.

2. Fix the metal plate A on the machine base with 4 M3 silver screws

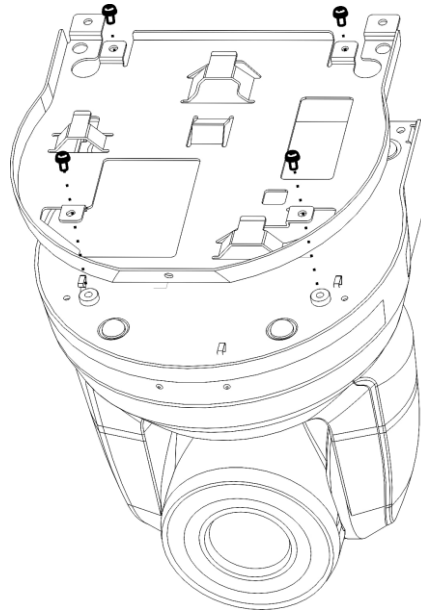

3. Lock the metal plate B on ceiling mounted hanger

※Caution:

(1) Please use the hanger that has obtained UL security approval

(2) Please reserve the hole for the connecting wires of the camera

4. Combine the metal plate A and the metal plate B

(1) Push the metal plate A up to the ceiling and then to the right to latch the metal plate B

(2) And then secure with 2 M3 silver screws and 1 M3 black screw

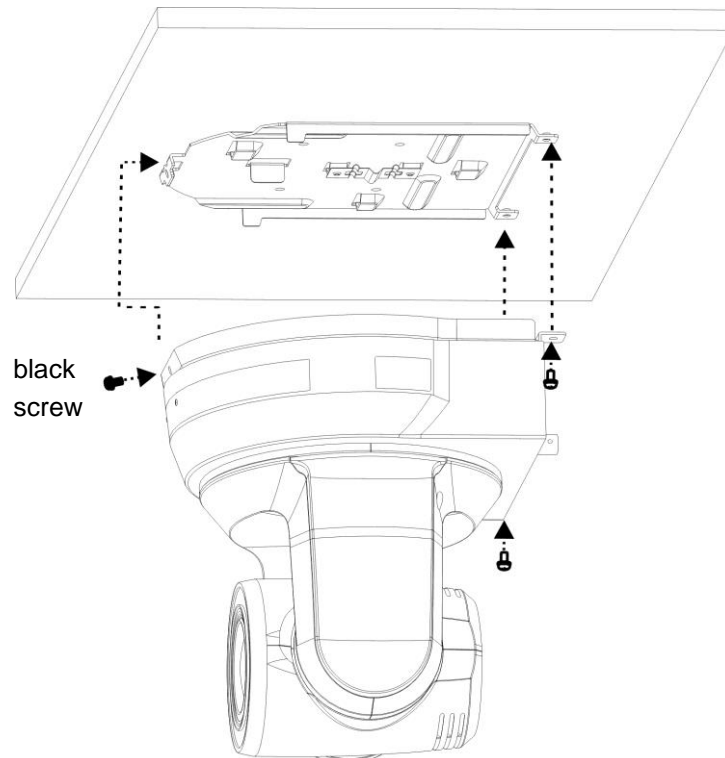

4.2.2.7 How to remove

1. Remove the connecting wires from the camera
2. Uninstall the camera together with the ceiling, loosen the three screws that fix the metal plates A and B and push to the left to remove the machine

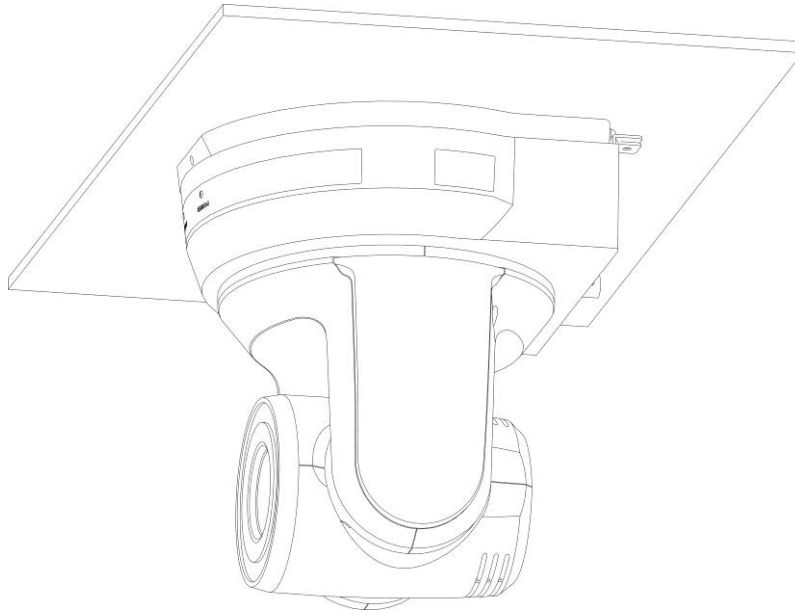

3. Then remove the screws on the hanger and the machine

4.3 Connecting devices

4.3.1 Image Output

4.3.1.1 Connecting to PC (video conference)

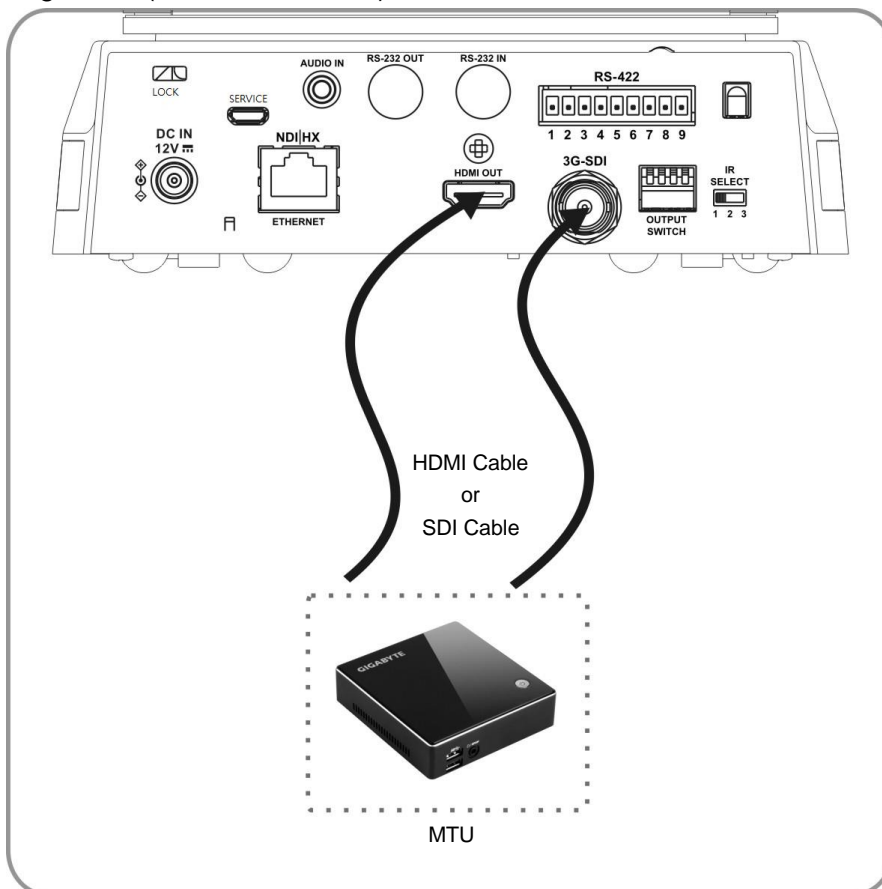

<Remark 1> SDI supports the audio output of 48 KHz only.

4.3.1.2 Connecting to an HDTV/computer monitor (HDMI)

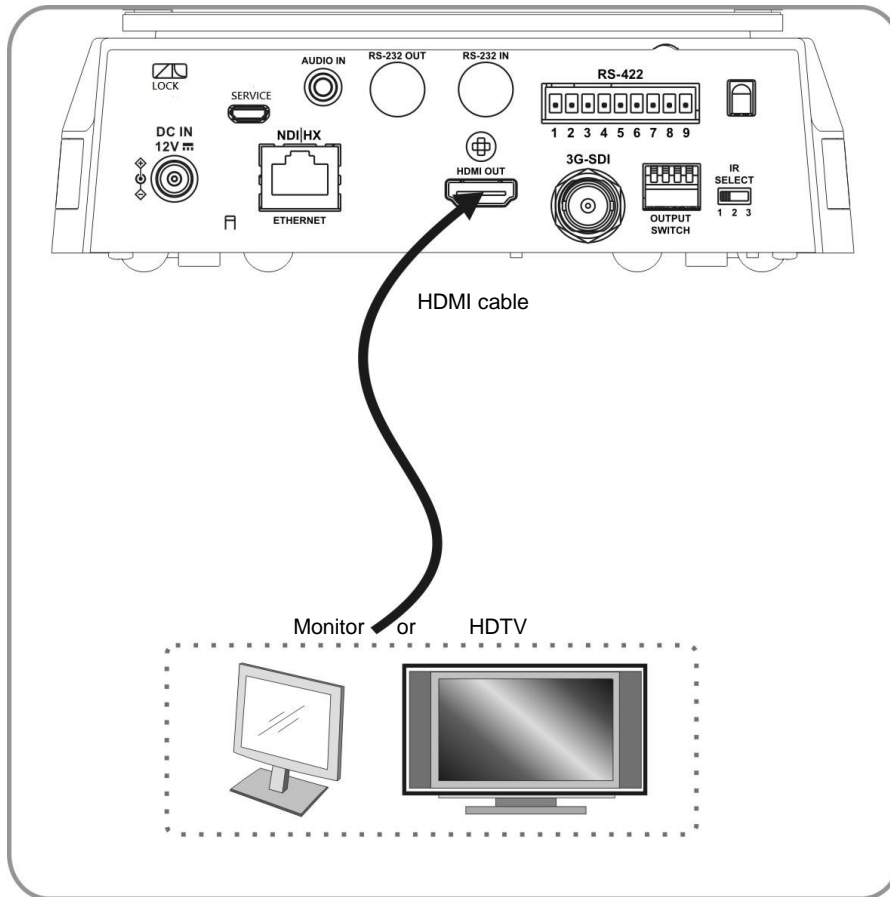

4.3.1.3 Connecting to Internet

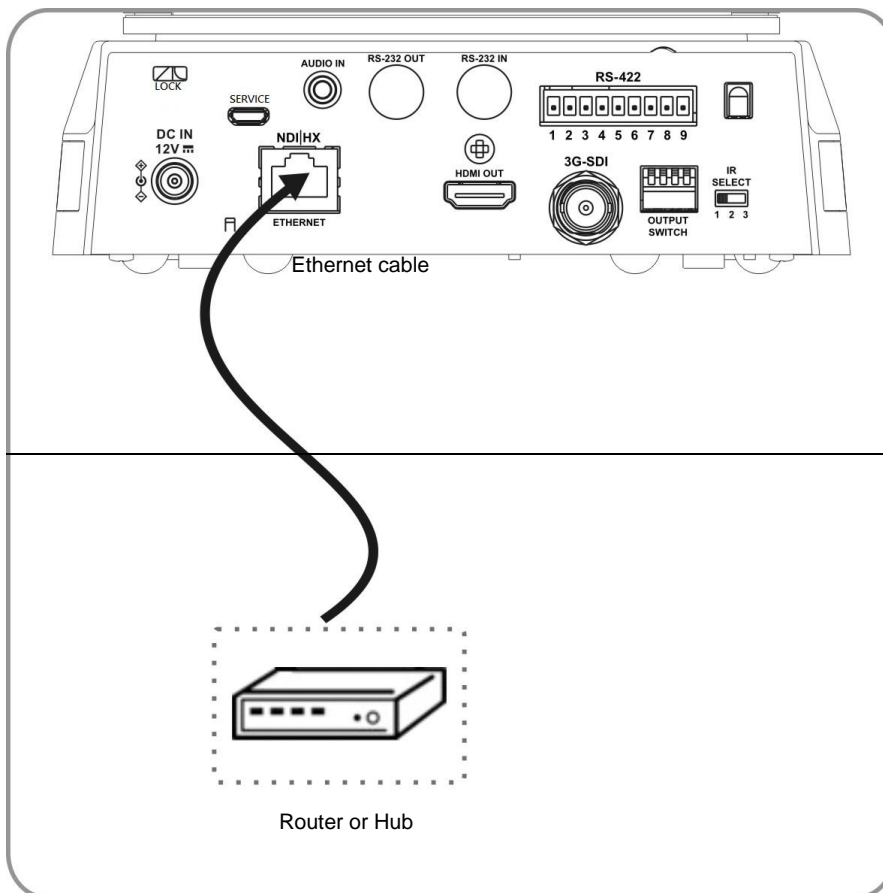

<Remark 1> VC-A50PN can be used with browsers, VLC and QuickTime after it is connected to the Internet.

<Remark 2> VC-A50PN supports PoE power supply when coupled with an IEEE 802.3at router or hub.

<Remark 3> For better performance, please use the ethernet cable of CAT 6 or above

4.3.1.4 Connecting AUDIO IN

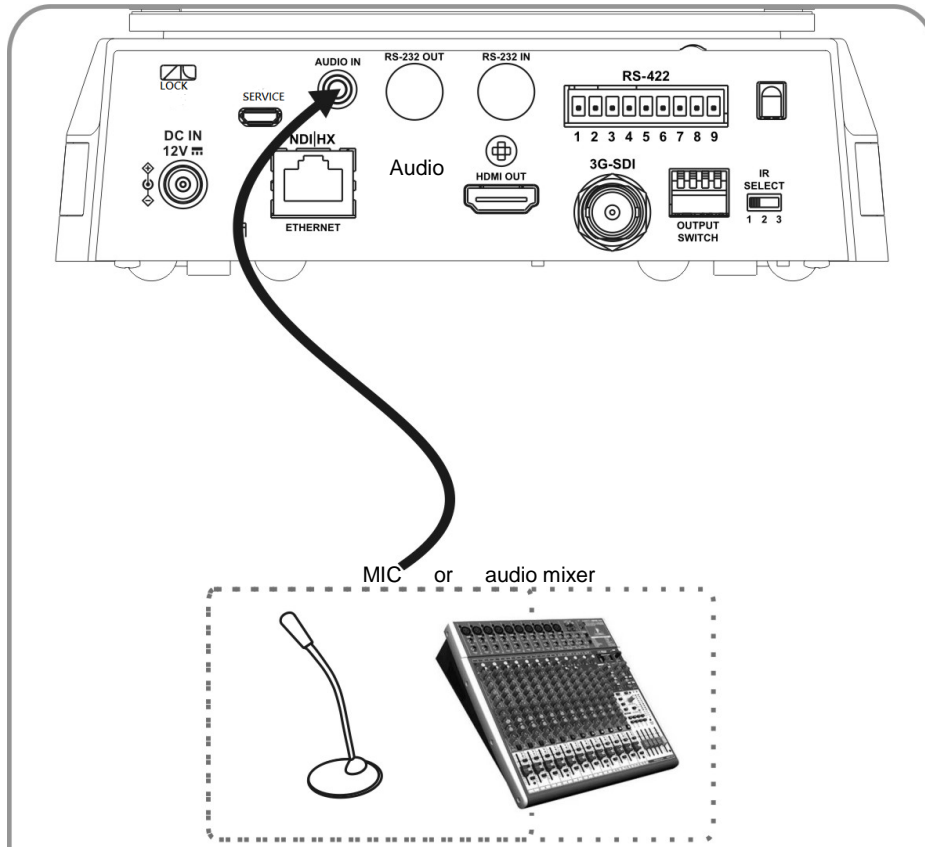

<Remark 1> Set the [Audio In] in the OSD to reflect the input device

4.3.2 Controlling VCs with the computer

4.3.2.1 Connecting to one computer for connection between VCs (RS-232 in/out)

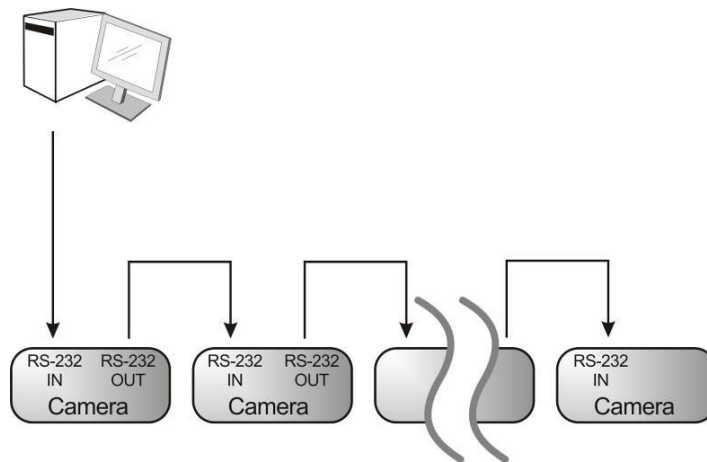

<Remark> With RS-232 in/out, at most 7 VCs can be connected.

4.3.2.2 Connecting to one computer for connection between VCs (RS-422)

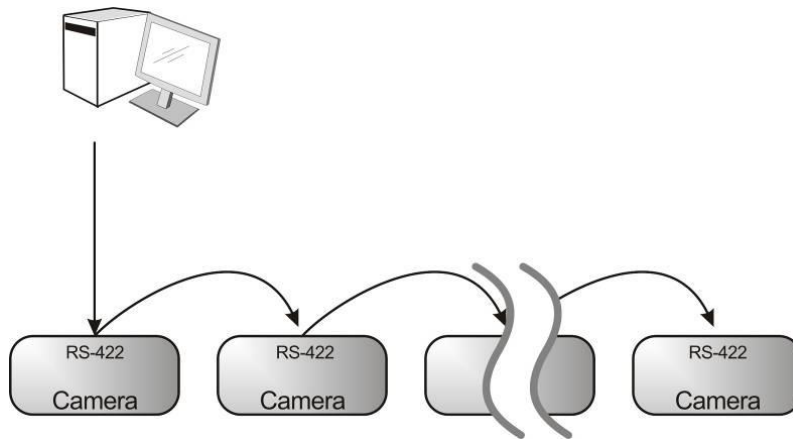

<Remark> Please refer to [8.2 RS-422 connection](#) for the RS-422 connection instructions.

<Remark> With RS-422, at most 7 VCs can be connected.

4.3.3 Use of VC-A50PN with Internet Connection

4.3.3.1 Setup before use

- Connecting the screen through HDMI output.
- Press [MENU] on the Remote Control to display the OSD menu.
- Shift down to [Ethernet] to modify and confirm the IP address
DHCP: Enable/disable the dynamic host configuration protocol
IP Address: Confirm or modify the IP address of VC-A50PN
Subnet mask: 255.255.255.0
Gateway: Preset 192.168.100.254

[Remark] Please modify the above settings based on the LAN setting of the operating environment. To use DHCP, please connect the VC-A50PN to LAN and then confirm IP address.

- After completing settings, press [MENU] to exit the OSD menu.
- After completing setting and confirming IP address, HDMI cable can be disconnected.

4.3.3.2 Start Using

- Connect network cable to VC-A50PN network port to connect VC-A50PN to LAN.
- Press [MENU] on the Remote Control to display the OSD menu.
- Open the browser, and enter the URL of VC-A50PN in the address bar, e.g.: <http://192.168.100.150> (default IP address)
- Enter administrator's account and password
Account: admin (Default)
Password: 9999 (Default)
Subnet mask: 255.255.255.0
Gateway: Preset 192.168.100.254

[Remark 1] For details, please refer to [Chapter 7 Network Function Settings Description](#).

[Remark 2] In addition to browsers, other software such as VLC and QuickTime can be used for operation.

Chapter 5 Remote Control and Setting Menu

5.1 Functions of remote control

<Remark> The below functions are listed alphabetically.

	Item	Description
	◀, ▶, ▲, ▼	Move the lens
	Back Light	Turn on/off back light compensation
	Camera select	Choose 1 ~ 3 of VC-A50PN
	Focus-Manual / Far/Near	Turn on manual focus to adjust the focal length
	Focus-Auto	Auto focus
	Freeze	Freeze the screen
	Home-Enter	Go back to the main page / Execute
	Info	Status information
	L/R Direction Set	L/R Direction / Normal
	Menu	Display OSD menu
	Mirror	Rotate the image (OFF / Mirror / Flip / Rotate)
	Pan/Tilt Reset	Clear the Pan / Tilt setting
	Picture	Switch image effect (OFF / NEG / Black & White)
	Power	Power Switch
	Preset	Appoint an ID (0 ~ 9) to save the current position data
	Reset	Appoint an ID (0 ~ 9) to delete the current position data
	Zoom-Fast	Adjust image size
	Zoom-Slow	Fine-tune image size

5.2 Setting Menu

<Remark> Press [Menu] on the remote control to enter the setting menu; the **bold underlined** values in the following table are defaults.

1st Level Major Items	2nd Level Minor Items	3rd Level Adjustment Values		Function Descriptions	
Exposure	Mode	1. Full Auto 2. Shutter Pri 3. Iris Pri 4. Manual 5. White Board 6. Smooth Auto		Exposure mode setting	
	Exposure Comp.	On / Off		AE Level	
	Exposure Comp. Level	-6~ 0 ~5		The value can be adjusted only after Exposure Comp. is activated	
	Shutter Pri		60/30 mode	50/25 mode	Shutter priority setting
			1/10000	1/10000	
			1/5000	1/5000	
			1/3000	1/3000	
			1/2500	1/2500	
			1/2000	1/1750	
			1/1500	1/1250	
			1/1000	1/1000	
			1/725	1/600	
			1/500	1/425	
			1/350	1/300	
			1/250	1/215	
1/180			1/150		
1/120			1/120		
1/100	1/100				
1/90	1/75				
		1/60	1/50		
		1/30	1/25		
		1/15	1/12		
		1/8	1/6		
		1/4	1/3		
		1/2	1/2		
		1/1	1/1		

	Iris Pri	<ol style="list-style-type: none"> 1. F1.6 2. F2 3. F2.2 4. F2.7 5. F3.2 6. F3.8 7. F4.5 8. F5.4 9. F6.3 10. F7.8 11. F9 12. F11 13. F13 14. F16 15. F18 		Iris setting																																													
	Manual Gain	<ol style="list-style-type: none"> 1. 0dB 2. 2 dB 3. 4 dB 4. 6 dB 5. 8 dB 6. 10 dB 7. 12 dB 8. 14 dB 9. 16 dB 10. 18 dB 11. 20 dB 		Manually set the gain																																													
	Manual Speed	<table border="1"> <tr> <td>60/30 mode</td> <td>50/25 mode</td> </tr> <tr><td>1/10000</td><td>1/10000</td></tr> <tr><td>1/5000</td><td>1/5000</td></tr> <tr><td>1/3000</td><td>1/3000</td></tr> <tr><td>1/2500</td><td>1/2500</td></tr> <tr><td>1/2000</td><td>1/1750</td></tr> <tr><td>1/1500</td><td>1/1250</td></tr> <tr><td>1/1000</td><td>1/1000</td></tr> <tr><td>1/725</td><td>1/600</td></tr> <tr><td>1/500</td><td>1/425</td></tr> <tr><td>1/350</td><td>1/300</td></tr> <tr><td>1/250</td><td>1/215</td></tr> <tr><td>1/180</td><td>1/150</td></tr> <tr><td>1/120</td><td>1/120</td></tr> <tr><td>1/100</td><td>1/100</td></tr> <tr><td>1/90</td><td>1/75</td></tr> <tr><td>1/60</td><td>1/50</td></tr> <tr><td>1/30</td><td>1/25</td></tr> <tr><td>1/15</td><td>1/12</td></tr> <tr><td>1/8</td><td>1/6</td></tr> <tr><td>1/4</td><td>1/3</td></tr> <tr><td>1/2</td><td>1/2</td></tr> <tr><td>1/1</td><td>1/1</td></tr> </table>	60/30 mode	50/25 mode	1/10000	1/10000	1/5000	1/5000	1/3000	1/3000	1/2500	1/2500	1/2000	1/1750	1/1500	1/1250	1/1000	1/1000	1/725	1/600	1/500	1/425	1/350	1/300	1/250	1/215	1/180	1/150	1/120	1/120	1/100	1/100	1/90	1/75	1/60	1/50	1/30	1/25	1/15	1/12	1/8	1/6	1/4	1/3	1/2	1/2	1/1	1/1	Manually set the shutter
60/30 mode	50/25 mode																																																
1/10000	1/10000																																																
1/5000	1/5000																																																
1/3000	1/3000																																																
1/2500	1/2500																																																
1/2000	1/1750																																																
1/1500	1/1250																																																
1/1000	1/1000																																																
1/725	1/600																																																
1/500	1/425																																																
1/350	1/300																																																
1/250	1/215																																																
1/180	1/150																																																
1/120	1/120																																																
1/100	1/100																																																
1/90	1/75																																																
1/60	1/50																																																
1/30	1/25																																																
1/15	1/12																																																
1/8	1/6																																																
1/4	1/3																																																
1/2	1/2																																																
1/1	1/1																																																

	Manual Iris	<ol style="list-style-type: none"> 1. <u>F1.6</u> 2. F2 3. F2.2 4. F2.7 5. F3.2 6. F3.8 7. F4.5 8. F5.4 9. F6.3 10. F7.8 11. F9 12. F11 13. F13 14. F16 15. F18 	Manually set the iris
	Gain Limit	<ol style="list-style-type: none"> 1. 8 dB 2. 10 dB 3. 12 dB 4. 14 dB 5. 16 dB 6. 18 dB 7. <u>20 dB</u> 	Max. limit value of electron gain
	Iris Limit	<ol style="list-style-type: none"> 1. F1.6 2. <u>F2.2</u> 3. F3.2 4. F4.5 5. F6.3 6. F9 7. F13 8. F18 	Max. limit value of iris
	WDR	<ol style="list-style-type: none"> 1. <u>Off</u> 2. 1 3. 2 4. 3 5. 4 6. 5 	WDR settings
White Balance	Mode	<ol style="list-style-type: none"> 1. <u>Auto</u> 2. Indoor 3. Outdoor 4. One Push WB 5. ATW 6. Manual 7. Sodium Lamp 8. 3000K 9. 4300K 10. 5000K 11. 6500K 12. 8000K 13. WideAuto 	Select the color temperature mode <ol style="list-style-type: none"> 1. 4000k ~ 7000k 2. 3200k 3. 5800k 4. 1700k ~ 10000k 5. 1700k ~ 10000k 6. Custom 7. 2800k 8. 3000K 9. 4300K 10. 5000K 11. 6500K 12. 8000K 13. 3000k ~ 7000k
	One Push Trigger	<u>ENTER</u>	One push trigger
	Manual Red	0~ <u>C</u> ~128	Adjustable when the white balance mode is set to Manual

	Manual Blue	0~ C ~128	Adjustable when the white balance mode is set to Manual
Picture	Picture effect	1. Off 2. Neg 3. B & W	Set the picture effect
	Sharpness	0~ C ~15	Adjust the sharpness of the image
	2D NR	1. Auto 2. Off 3. 1 4. 2 5. 3 6. 4 7. 5	2D noise reduction settings
	3D NR	1. Off 2. Low 3. Typ 4. Max 5. Auto	3D dynamic noise reduction settings
	Image Mode	1. Mode 1 2. Mode 2 3. Mode 3 4. Mode 4 5. Mode 5 6. Mode 6 7. Custom	The user may customize his/her desired image mode.
	Image Mode Load	1. Mode 1 2. Mode 2 3. Mode 3 4. Mode 4 5. Mode 5 6. Mode 6	Adjustable when the image mode is set to Custom . After selected, the corresponding image mode parameters will be read and applied to Custom
	Brightness	0~ C ~25	Adjustable when the image mode is set to Custom
	Contrast	0~ C ~25	Contrast adjustment; Adjustable when the image mode is set to Custom
	Saturation	0~ C ~25	Adjustable in the Custom Mode
	Black Level	1. Off 2. Type 1 3. Type 2 4. Type 3 5. Type 4 6. Type 5	Adjustable in the Custom Mode
	Gamma	0~ C ~3	Adjustable in the Custom Mode
Skin Tone	0~ C ~5	Skin tone setting, adjustable in the Custom Mode	
Pan Tilt Zoom	Pan/Tilt Limit	ON/ Off	Turn on/off the angle limit setting
	Pan Right Limit	0~ 170	Limit the right angle
	Pan Left Limit	-170 ~0	Limit the left angle
	Tilt UP Limit	0~ 90	Limit the upward angle
	Tilt Down Limit	-30 ~0	Limit the downward angle

	Pan Flip	On/ <u>Off</u>	Activate the reverse Pan command
	Tilt Flip	On/ <u>Off</u>	Activate the reverse Tilt command
	Preset Speed	1. 5 per second 2. 15 per second 3. 25 per second 4. 35 per second 5. 50 per second 6. 75 per second 7. 100 per second 8. 120 per second	Set the rotation speed of the cradle head when Preset is executed
	PTZ Speed Comp	On/ <u>Off</u>	PTZ Speed Compensation
	Zoom Limit	x1 ~ x20	Optical zoom limit
Dig-Effect	Mirror	1. <u>Off</u> 2. Mirror 3. Flip 4. Mirror + Flip	Set the mode at which the image is turned
Auto Focus	AF Sensitivity	1. Low 2. Middle 3. High	Select the AF triggering speed. The higher the speed is, the faster AF is triggered
	AF speed	Fast / Normal	Focus speed after AF triggering
	AF Frame	Full Frame /Center	AF frame setting, when central area was set as AF frame, focusing will be on the center of the screen. When Full Frame was set as AF frame, focusing will be calculated based on the full screen
	PTZ Assist	<u>On</u> / Off	Turn on Auto Focus in manual mode
Ethernet	DHCP	<u>On</u> / Off	Enable/Disable DHCP setting using left and right arrow keys and press [ENTER] to apply setting.
	IP Address	192.168.100.150	Press [ENTER] to modify the items; select the item to be modified using left and right arrow keys, and modify the value using numeric keys.
	Subnet mask	255.255.255.0	Press [ENTER] to modify the items; select the item to be modified using left and right arrow keys, and modify the value using numeric keys.
	Gateway	192.168.100.254	Press [ENTER] to modify the items; select the item to be modified using left and right arrow keys, and modify the value using numeric keys.
Audio	Audio In	Line In /Mic In	Set Audio In
	Audio Enable	On / <u>Off</u>	Turn on/off audio output
	Audio Volume	0~ C ~10	Volume Setting
	Audio Delay	0 ~ 500 ms/ <u>Off</u>	Set audio delay
	Encode Sample Rate	1. 48 KHz (AAC) 2. 44.1 KHz (AAC) 3. 16 KHz (G.711) 4. 8 KHz (G.711)	Set the encode type and sample rate SDI supports the audio output of 48 KHz only.
System	Prompt	On / <u>Off</u>	Turn on/off the prompt information on the display

	IR Receive	<u>On</u> / Off	Turn on/off the infrared reception
	Motionless Preset	On / <u>Off</u>	When the function is enabled, the screen will Freeze when Preset is executed. Freeze will be released after Preset is completed.
	Tally Lamp	<u>Enable</u> / Disable	Turn on/off the Tally Mode
	Language	<u>English</u> / Chinese	Language
	Initial position	<u>Last MEM</u> / 1st Preset	Select the camera lens to return to the last operated position or the first preset position after POWER ON
	Output Mode	<ol style="list-style-type: none"> 1. <u>1080p/60</u> 2. 1080p/59.94 3. 1080p/50 4. 1080p/30 5. 1080p/29.97 6. 1080p/25 7. 1080i/60 8. 1080i/59.94 9. 1080i/50 10. 720p/60 11. 720p/59.94 12. 720p/50 	Set output resolution <Remark> For HDMI/SDI output, when 1080i mode is set, NDI output is 1080p
	Control Device	Encoder / <u>Controller</u>	Control Device setting Controller: Used as a joystick Encoder: Used for tracking system
	Protocol	<u>Protocol V</u> / Protocol PD	Protocol V: VISCA Protocol PD: PELCO D
	PD Address	1~ <u>C</u> ~255	The Protocol set to PD allows the camera ID address to be assigned
	Factory Reset	On / <u>Off</u>	Resume the factory default setting
	FW Upgrade	On / <u>Off</u>	Upgrade Firmware
Status			Display the current setting status

Chapter 6 Descriptions of Major Functions

6.1 I would like to switch to VC-A50PN

1. Press [**Camera 1 ~ 3**] on the **remote control** to select VC-A50PN.
 - **Camera 1 ~ 3 is selected with IR SELECT.**

6.2 I would like to save the current lens position data

1. Hold [**Preset + ID**] on the **remote control** to save the current position data.
 - **ID shall be a digit [0 ~ 9].**
 - **Use VISCA Command to store position data to [0 ~ 127]**

6.3 I would like to clear the saved position data

1. Hold [**Reset + ID**] on the **remote control** to clear the given position data.
 - **ID shall be a digit [0 ~ 9].**
 - **Use VISCA command to clear position data stored in [0 ~ 127]**

6.4 I would like to turn on the back light compensation function

1. Press [**Back Light**] on the **remote control** to turn on or turn off the back light compensation

6.5 I would like to adjust the shooting angle of the lens

1. Press [**Tilt ▲**] or [**Tilt ▼**] on the **remote control** to adjust the angle upward or downward.
2. Press [**Pan ►**] or [**Pan ◀**] on the **remote control** to adjust the angle to right or left.
3. Press [**Pan - Tilt Reset**] on the **remote control** to reset the angle to the center point.

6.6 I would like to zoom in/out images

6.6.1 Adjust image size

1. Press [**Fast +**] on the **remote control** to zoom in images.
2. Press [**Fast -**] on the **remote control** to zoom out images.

6.6.2 Fine-tune image size

1. Press [**Slow +**] on the **remote control** to zoom in images.
2. Press [**Slow -**] on the **remote control** to zoom out images.

6.7 I would like to adjust the focal length

6.7.1 Auto tune

1. Press [**AF**] on the **remote control** to adjust automatically.

6.7.2 Manual focus

1. Press [**MF**] on the **remote control** to turn on the manual focus function.
2. Press **Focus - [+]** or **Focus - [-]** to adjust.

6.8 I would like to adjust the AF speed

6.8.1 Adjust the AF Sensitivity

Triggering speed of focus. The higher the speed is, the faster focus is triggered

To shoot fast-moving objects, **AF Sensitivity** can be set to [**High**] or [**Medium**], which is applicable to quick

focus.

When the environment is too dark to enable auto focus or fixed objects have to be shot in different brightness, **AF Sensitivity** can be set to **[Low]**.

1. Press [MENU] to activate the setting menu.
2. Press [▶] or [◀] to select [Auto Focus].
3. Press [ENTER] to activate.
4. Press [▲] or [▼] to select [AF Sensitivity].
5. Press [ENTER] to activate.
6. Press [▶] or [◀] to select [High / Middle / Low].
7. Press [MENU] to exit.

6.8.2 Adjust the AF speed

The focus speed upon triggering **AF Sensitivity**

- **[Normal]** (default): Image flickering may not occur
 - **[Fast]**: Fast focus speed
1. Press [MENU] to activate the setting menu.
 2. Press [▶] or [◀] to select [Auto Focus].
 3. Press [ENTER] to activate.
 4. Press [▲] or [▼] to select [AF speed].
 5. Press [ENTER] to activate.
 6. Press [▶] or [◀] to select [Fast / Normal].
 7. Press [MENU] to exit.

6.9 I would like to set the image mode

1. Press [Picture] on the **remote control** to switch [Off / Neg / B&W].

6.10 I would like to freeze images

1. Press [Freeze] on the **remote control** to freeze the current image on the display.

6.11 I would like to rotate the image

1. Press [Mirror] on the **remote control** to switch [Off / Mirror / Flip / Mirror + Flip].

6.12 I would like to change the camera direction

1. Press [L/R Direction Set] on the **remote control** to switch [L/R Direction / Normal].

6.13 I would like to display the current status

1. Press [Info] on the **remote control** to display the current status information. `

6.14 I would like to reset to the default value

Reset to default value using OSD menu or Remote Control combination key

- **OSD menu:** Press [MENU] → [System] → [Factory Reset] → [On] → [Enter] on the Remote Control and reset to the default value
- **Remote Control combination key:** press [+] → [8] → [8] → [6] → [Enter] one by one on the Remote Control in order to reset to the default value

Chapter 7 Network Function Settings Description

7.1 Web System Requirements

Web Browser

- Internet Explorer 11 and above
- FireFox 59.0.2 and above
- Chrome 65.0.3325.181 and above
- Edgi 41.16299.15 and above
- Safari 11.0.3 and above

7.2 Online IP Camera

7.2.1 Connecting to Internet

Two common connection methods are shown below

1. Connecting via switch or router

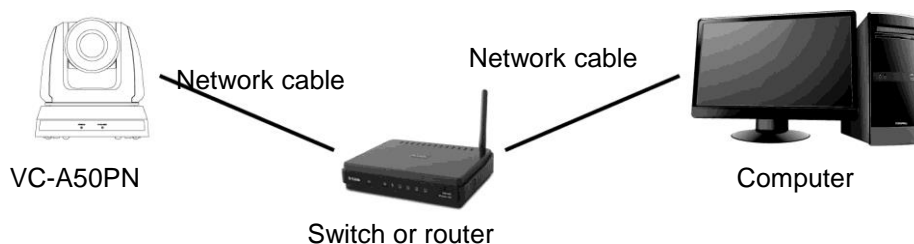

2. To connect directly through network cable, the IP address of the computer should be changed so that it is on the same network segment as the camera; for instance 192.168.100.x (preset for camera)

- Connection diagram

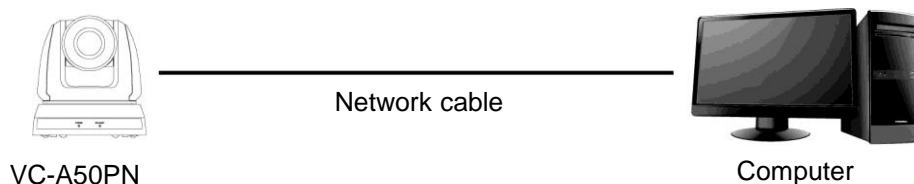

- Change network settings

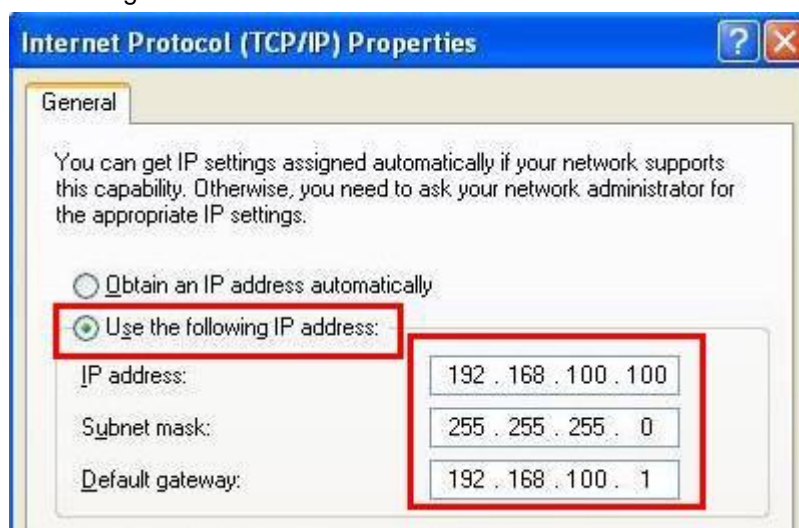

7.2.2 Use the web browser

1. Open the IE browser, and enter the URL of VC-A50PN in the address bar, such as: <http://192.168.100.150> (default IP address)
2. Enter administrator's account and password to get started
Account: admin (Default)
Password: 9999 (Default)

- <Remark> 1. "WebPlugin" must be installed before the first use. Please install the program after downloading according to instructions on the screen (as shown in the following figure)
2. Please login the computer as Administrator to install it
 3. After completing installation, please refresh the page.

Installation Guide

The "WebPlugin" file will be downloaded automatically in 7 seconds...

Step:

- 1. Before you begin, close your web browser (i.e. Internet Explorer, Firefox, Chrome, etc.) first.



- 2. Double-click "WebPlugin.exe" to start the actual installation process.

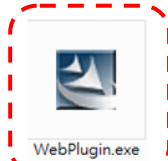

- 3. After installation is completed, open the web browser and type in the IP address of the IP Camera



7.3 Web Page Function Description

7.3.1 Login Screen

	Username: Enter user account
	Password: Enter user password
	Select Language: Select language from English, Traditional Chinese and Simplified Chinese
	Remember password: Remember the password so that you do not need to type it next time
	Login: Log into the administrator screen on the website

7.3.2 Live View

< Remark > VC-A50PN does not support RTSP streaming, and the preview window cannot be displayed. This item only supports PTZ and preset location setting.

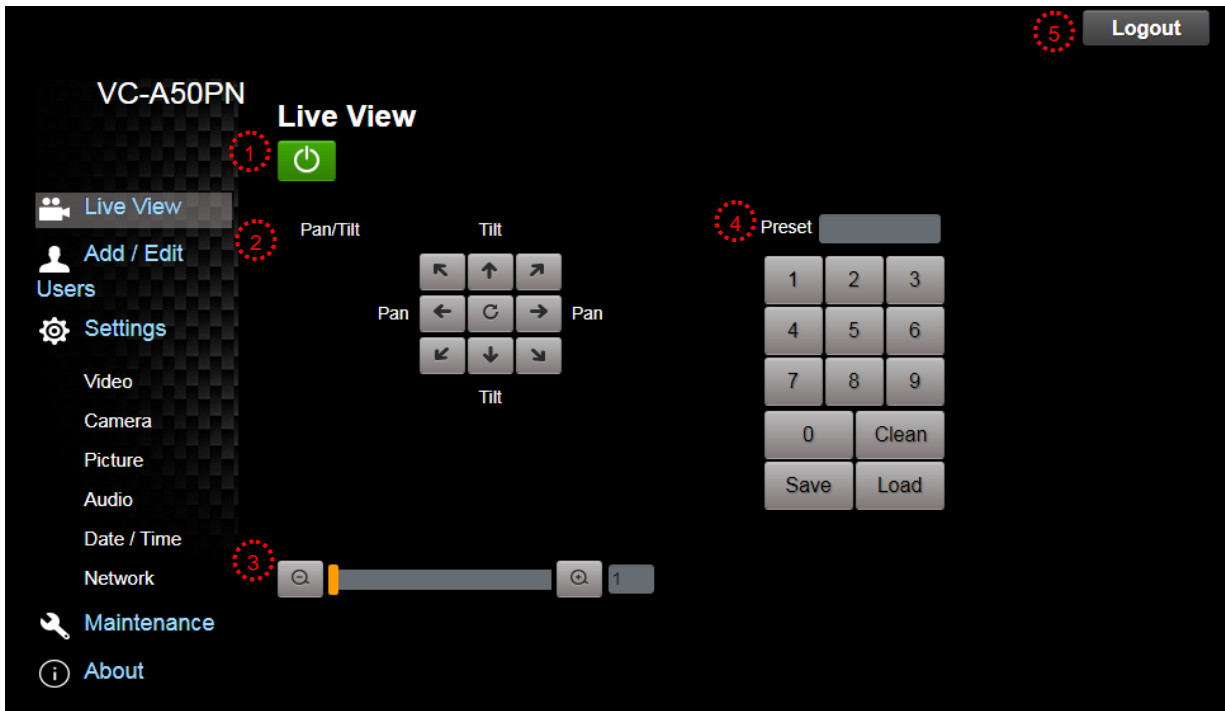
1. Power off VC-A50PN
2. Rotate camera angle
3. Zoom in/out
4. Apply/Set preset
5. Logout

7.3.3 Account management screen

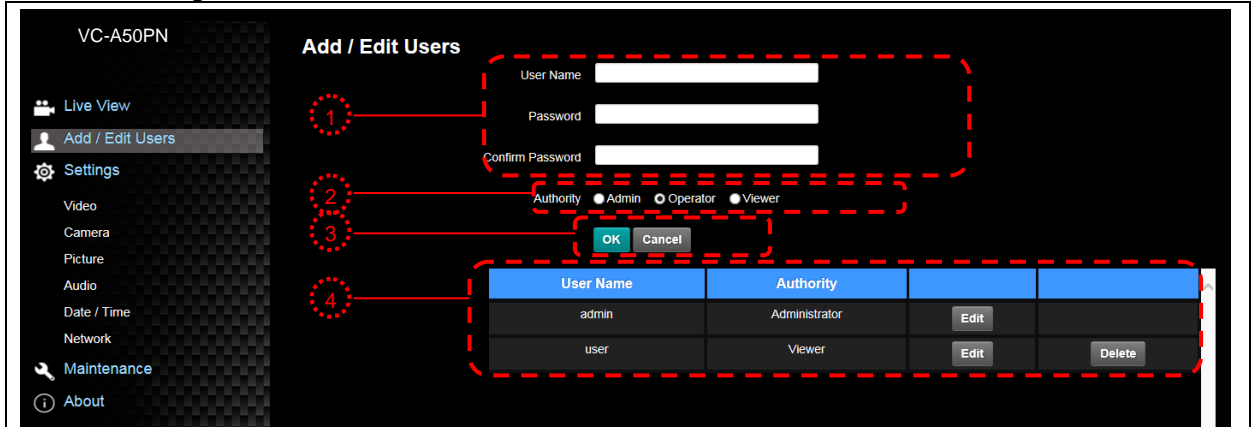

1. Enter new username and password

2. Set the permissions: Description for permissions is listed in the following table

3. Apply

4. List of accounts:

Edit: Change password and permission of new account

Delete: Delete new account

<Remark> Reference for User Permissions

User Type	Admin	Operator	Viewer
View images	Y	Y	Y
Settings	Y	Y	N
User accounts management	Y	N	N

7.3.4 Settings – Video Setting

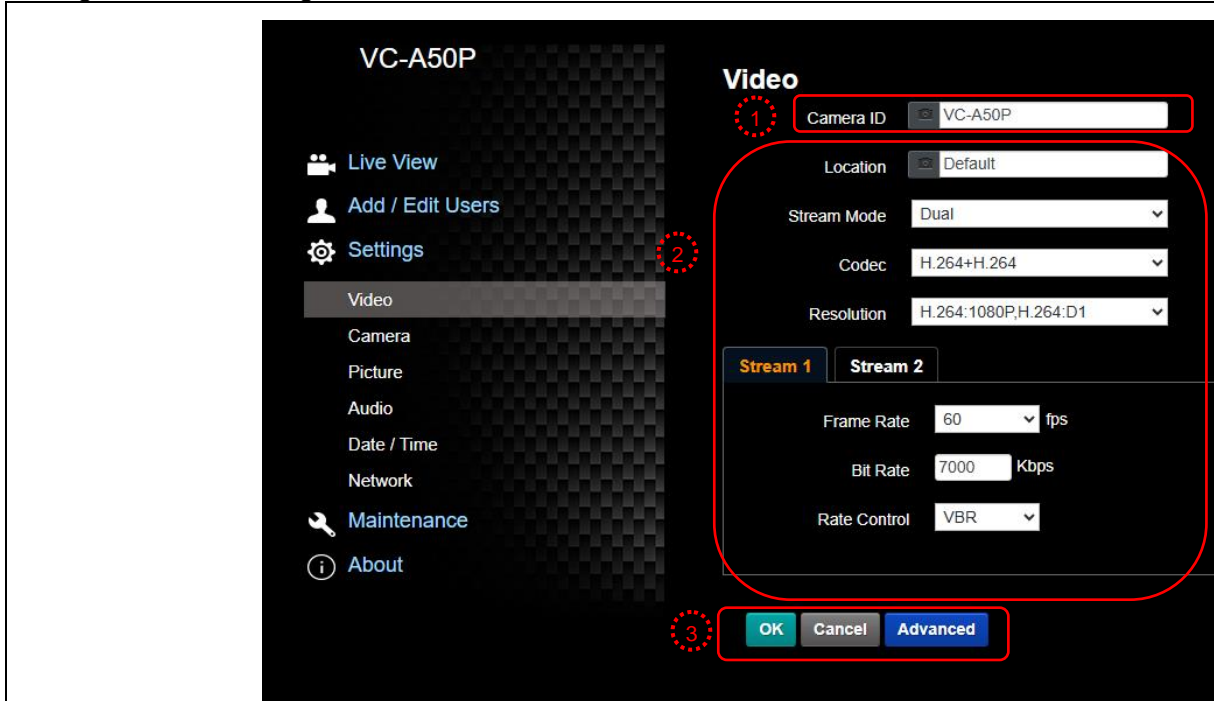

1. Create a desired ID for the camera.

2. Location, Resolution, Stream type, Codec

3. Apply/Cancel. Advanced setting.

7.3.5 Setting – Video – Advanced

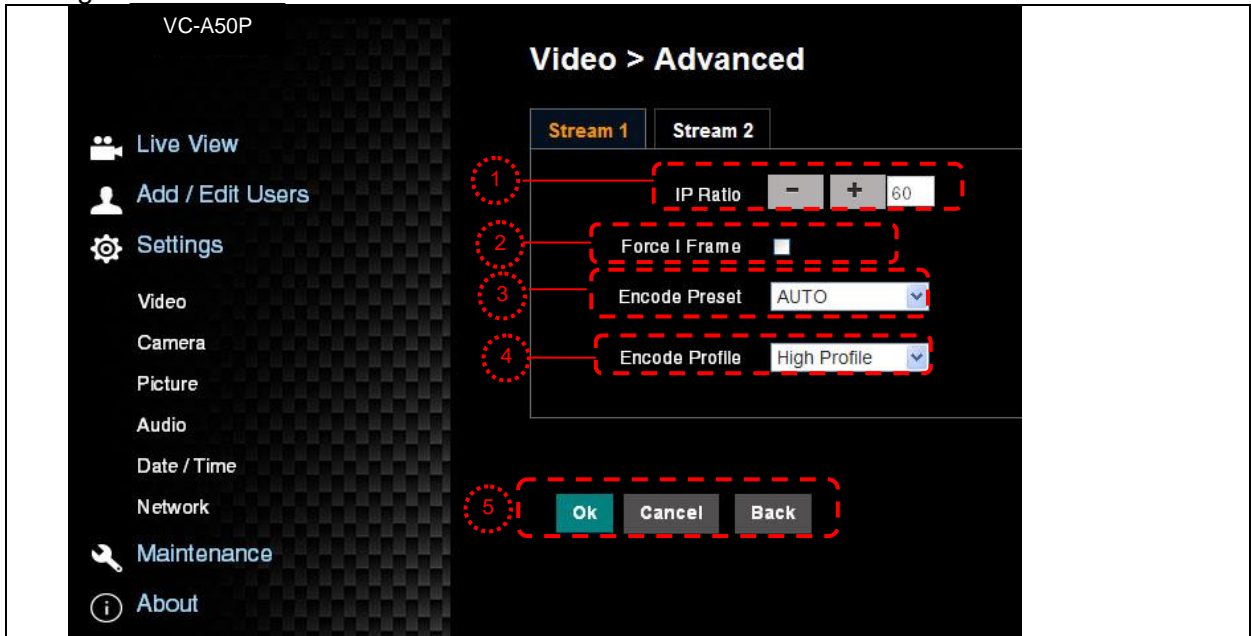

1. IP Ratio: Set IP Ratio, from 1 to 60

2. Force I Frame :

Check this item to insert IDR frame into specified series flow and apply its setting. User's setting will be reserved and displayed in GUI interface

3. Encode Preset :

Auto: Select between speed and quality depending on the encoding method used (e.g. HIGH_SPEED mode for refresh rate of 60 frames per second and HIGH_QUALITY mode for high image quality)

HIGH_SPEED: Refresh rate of 60 frames per second is available

HIGH_QUALITY: Higher image quality can be obtained.

4. Encode Profile: Encoded Information

5. Preset Save

<Remark> SVC connection address: rtsp://VC IP Address:Port/h264

60 / 30 Frame: rtsp://VC IP Address:8557/h264, E.g.: <rtsp://192.168.100.150:8557/h264>

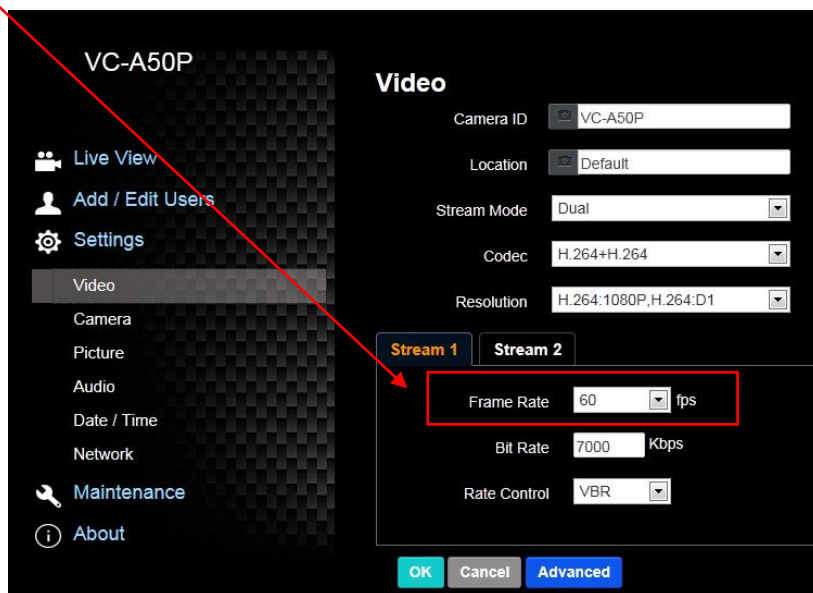

7.3.6 Setting - camera

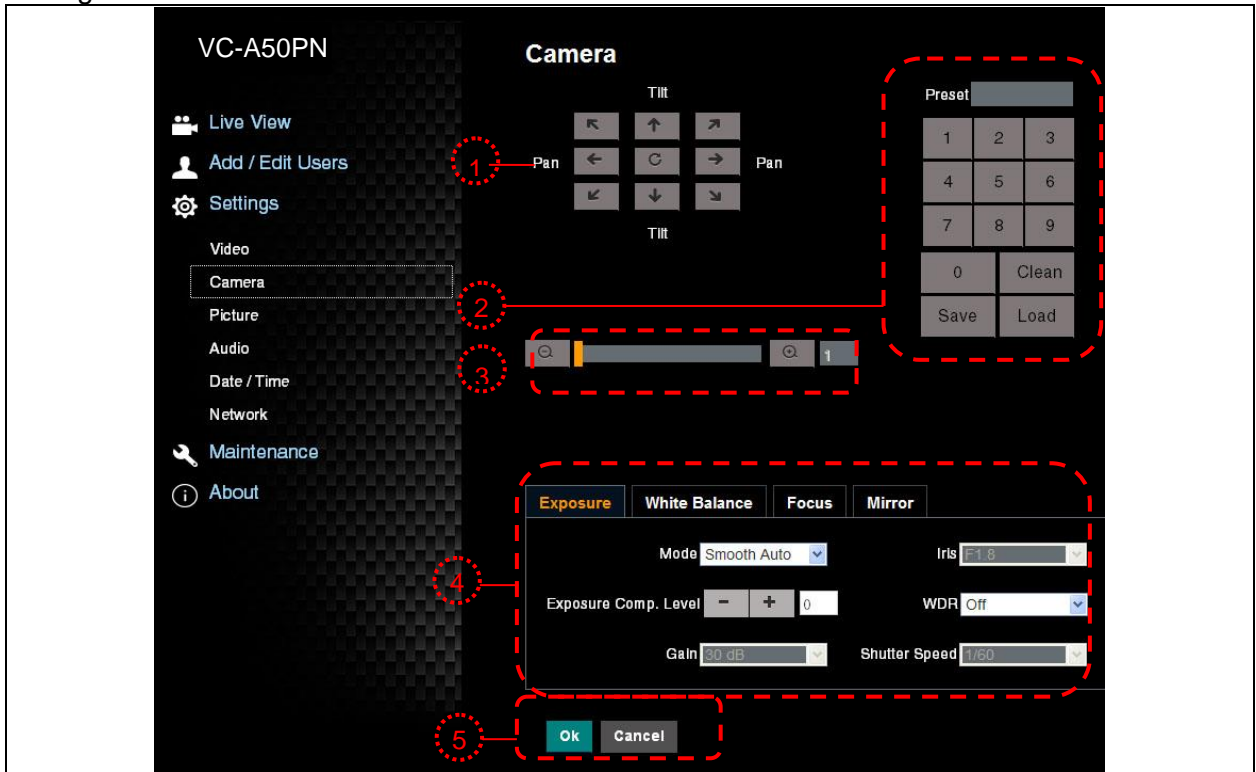

1. Rotate camera lens angle

2. Save/Read preset

3. Adjust image size

4. Adjust camera settings. Please refer to [7.3.6 Settings - Advanced Camera Setting](#)

5. Preset Save

7.3.7 Settings –Advanced Camera Setting

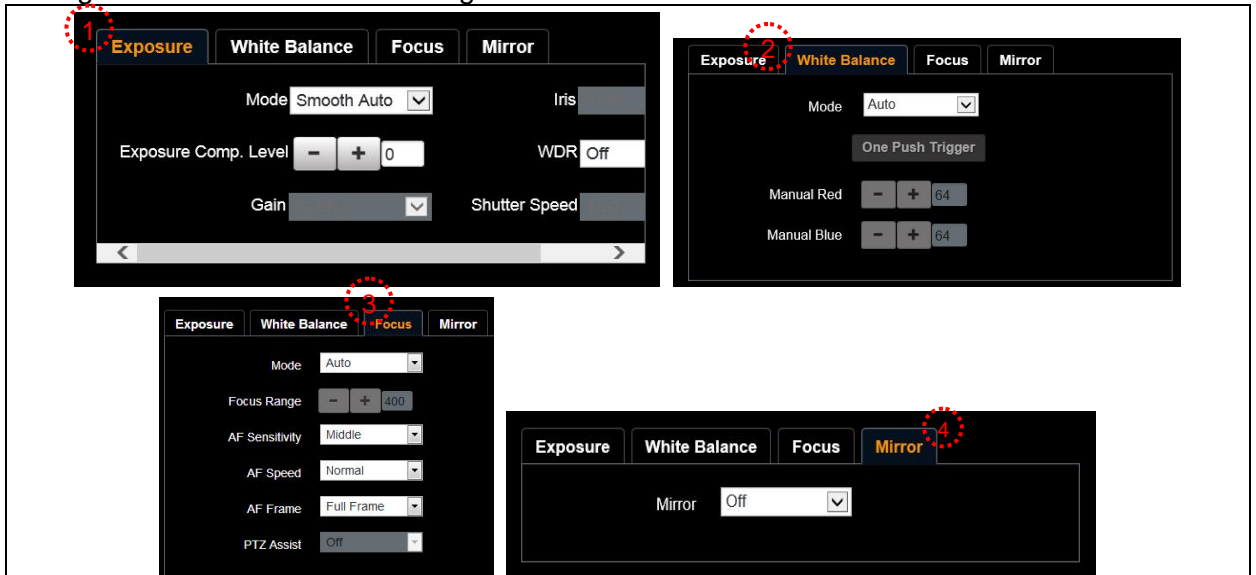

1.. Exposure:

- **Mode:** Select exposure mode
- **Exposure Comp. Level:** Select exposure compensation level
- **Gain:** Adjust gain restriction
- **Iris:** Iris setting
- **WDR:** WDR settings

<ul style="list-style-type: none"> ● Shutter Speed: Shutter settings
<p>2. White Balance:</p> <ul style="list-style-type: none"> ● Mode: Select the color temperature mode ● Open Push Trigger: Single color temperature execution adjustment ● Manual Red/Blue: Manually adjust blue/red color temperature
<p>3. Focus:</p> <ul style="list-style-type: none"> ● Mode: Select manual/automatic focus ● Focus Range: Set focus range ● AF Sensitivity: Set automatic focus sensitivity ● AF Speed: Set automatic focus speed ● AF Frame: Set automatic focus range ● PTZ Assist: Set Auto Focus in manual mode
<p>4. Mirror:</p> <ul style="list-style-type: none"> ● Mirror: Set automatic flip mode

7.3.8 Settings – Picture Setting

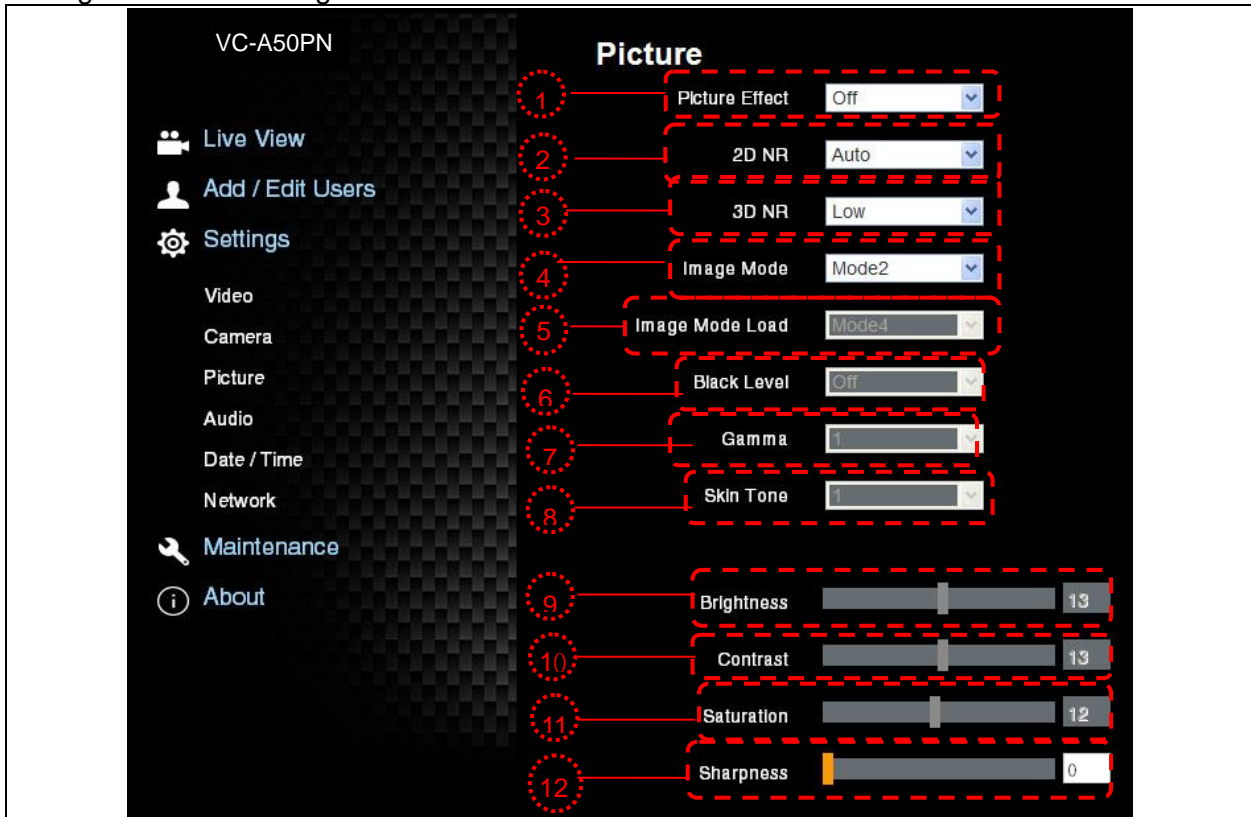

1. Picture Effect: Set the picture effect
2. 2D NR: 2D noise reduction settings
3. 3D NR: 3D dynamic noise reduction settings
4. Image Mode: The user may customize his/her desired image mode
5. Image Mode Load: Adjustable when <i>Image Mode</i> is set to <i>Custom</i> , similar to OSD
6. Black Level: Adjustable when <i>Image Mode</i> is set to <i>Custom</i> , similar to OSD
7. Gamma: Adjustable when <i>Image Mode</i> is set to <i>Custom</i> , similar to OSD
8. Skin Tone: Skin tone settings; adjustable when <i>Image Mode</i> is set to <i>Custom</i> , similar to OSD
9. Brightness: Adjustable when <i>Image Mode</i> is set to <i>Custom</i> , similar to OSD
10. Contrast: Adjustable when <i>Image Mode</i> is set to <i>Custom</i> , similar to OSD

11. **Saturation:** Adjustable when *Image Mode* is set to *Custom*, similar to OSD

12. **Sharpness:** Adjust the **sharpness** of the image

7.3.9 Settings – Audio Setting

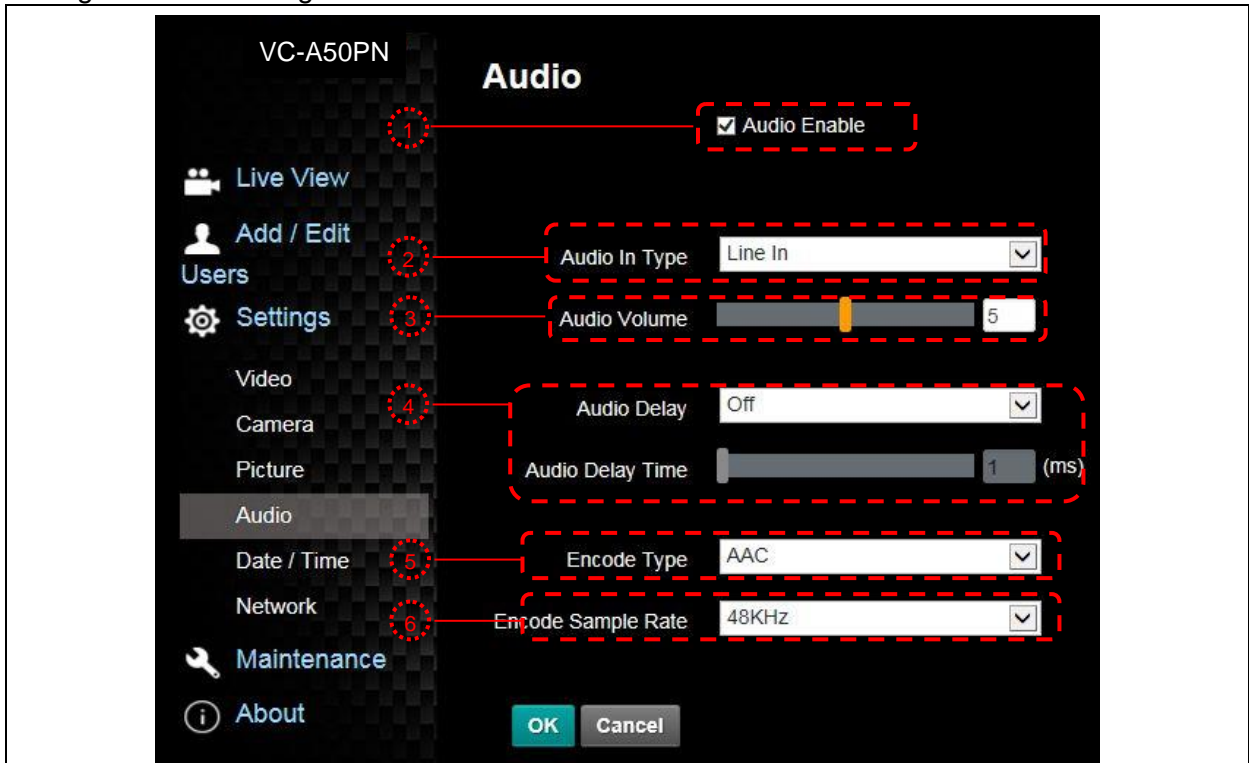

1. Turn on/off sound

2. Set MIC In/Line In

3. Adjust the Volume

4. Set audio delay

5. Set **Encode Type (ACC / G.711)**

6. Set **Encode Sample rate**

7. Preset Save

7.3.10 Settings- Date/ Time Setting

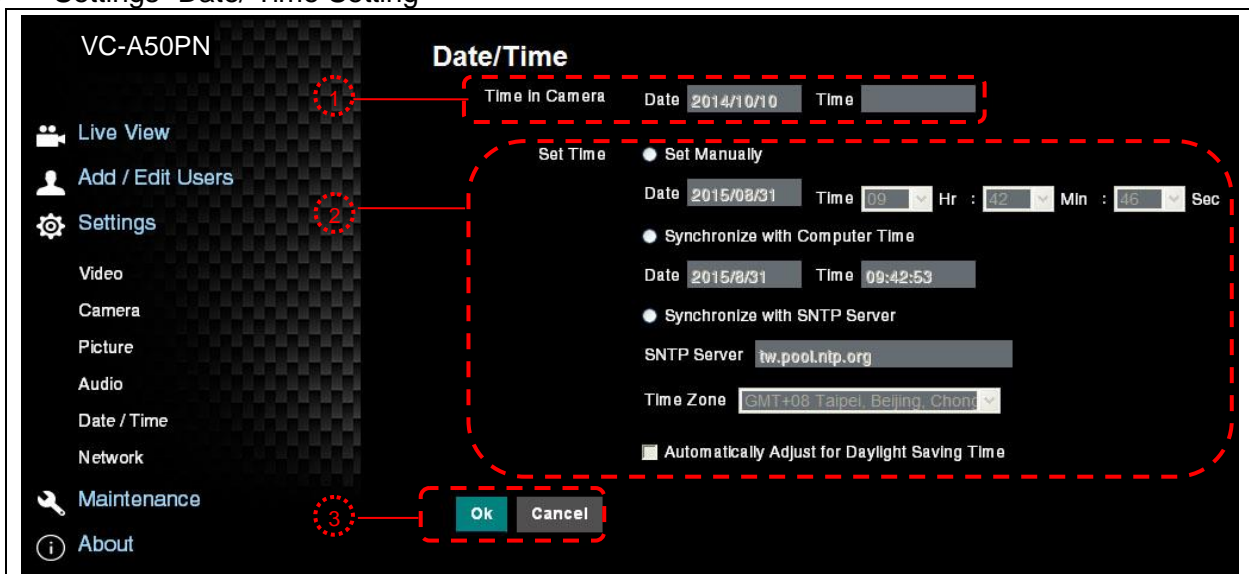

1. Current camera date and time

2. Set the Time: Manual setting/synchronous computer time/synchronous SNTP server time/time of automatic adjustment of daylight saving

3. Preset Save

<Remark> SNTP server address: Please change in network setting

7.3.11 Setting -- Network and Port Setting

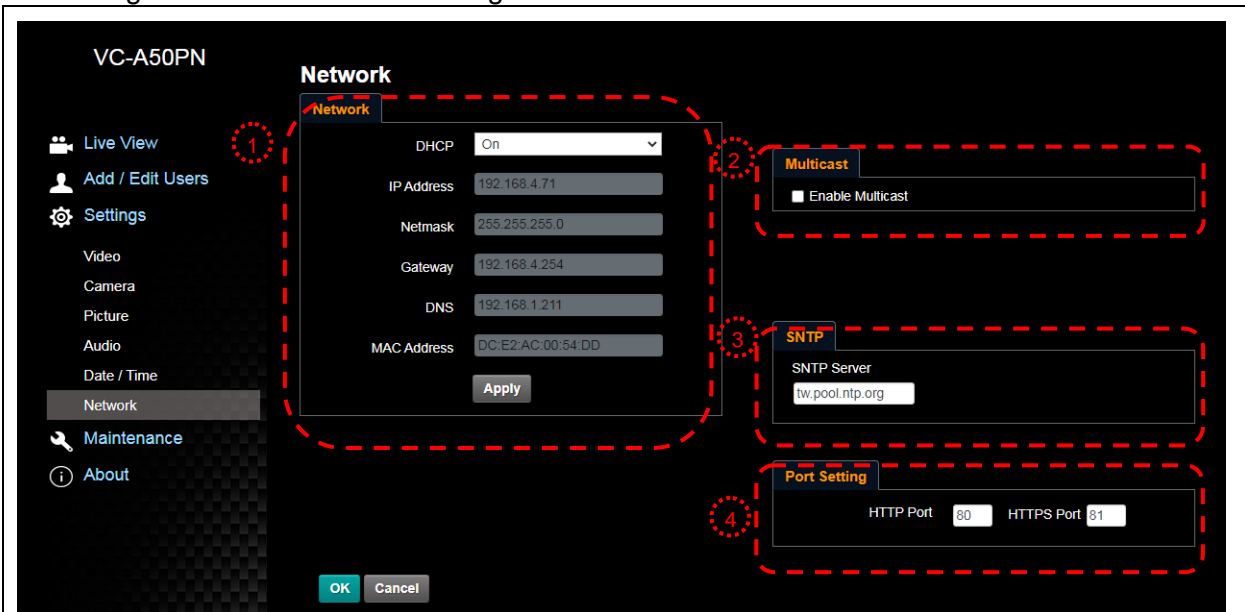

1. Network address of camera: Change of setting is available only when DHCP function of camera is turned off; please turn off DHCP function using VC-A50PN screen menu, and for setting of each item of screen menu, see [5.2 Setting Menu](#)

2. Enable/Disable Multicast

<Remark> It is suggested to enable Multicast when the number of users online watching the live image simultaneously is more than 4.

3. Set SNTP: Set SNTP Server IP

4. Set HTTP port. The default Port value is 80

<Remark> Change of setting is available only when DHCP function of camera is closed

7.3.12 Maintenance

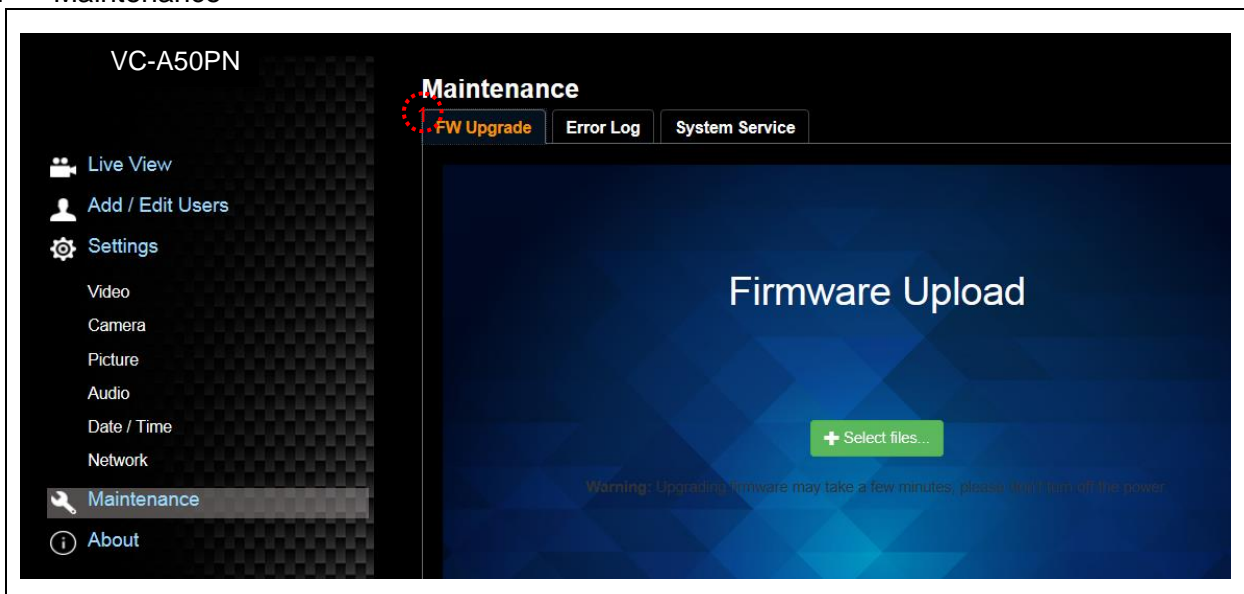

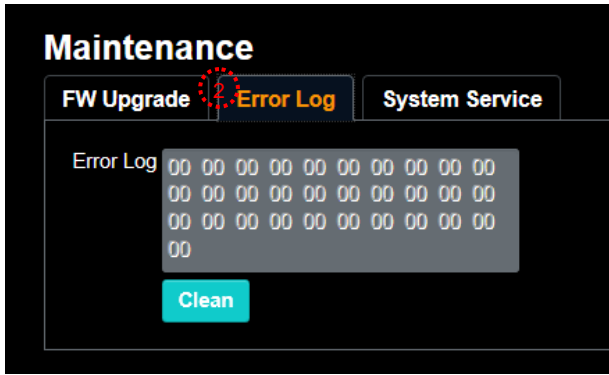
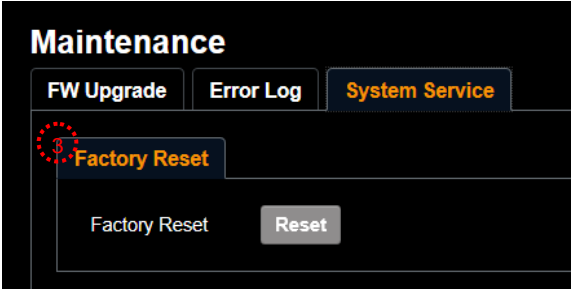
	
1. Firmware Upload	
2. Error Log	
3. Factory Reset	

Chapter 8 DIP switch setting

<Note> Please turn off the machine before changing DIP switch setting.

8.1 DIP SWITCH

8.1.1 OUTPUT Switch



Output Mode	Setting	Output Mode	Setting
1920x1080p/60		1920x1080p/50	
1920x1080p/30		1920x1080p/25	
1920x1080i/60		1920x1080i/50	
1280x720p/60		1280x720p/50/4	
1080p/59.94		1080i/59.94	
1080p/29.97		720p/59.94	

<Remark>For HDMI/SDI output, when 1080i mode is set, NDI output is 1080p

8.1.2 IR SELECT



ID	Setting
1	
2	
3	

8.1.3 Camera Address Selector



Setting	Function Descriptions
0~7	ID 0~7
8~9	Reserved

8.1.4 System Switch



Setting	Function Descriptions
DIP 1	RS-232C/RS-422 selector OFF : RS-232C / ON : RS-422
DIP 2	Infrared signal output switch OFF : Off / ON : On
DIP 3	Communication baud rate selector OFF : 9600 / ON : 38400
DIP 4	Reserved

8.2 RS-422 Connection

8.2.1 RS-422 Pin Description

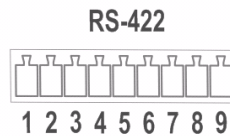

Pin NO.	Function
1	RXD OUT -
2	RXD OUT +
3	TXD OUT -
4	TXD OUT +
5	GND
6	RXD IN -
7	RXD IN +
8	TXD IN -
9	TXD IN +

<Note>

Please connect IN+ to OUT+ when connecting to SONY products

For non-SONY products, it may be necessary to connect IN+ to OUT-

8.2.2 Use RS-422 Connection

1. Hold the two sides of RS-422 connector and pull out in the direction shown by the arrow in the figure below

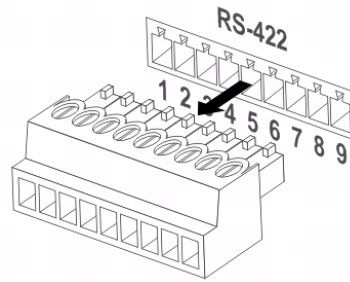

2. Peel off a section of copper wire (AWG Nos.28 to 18) and insert it into the connector hole; then use flat screw driver to fix it

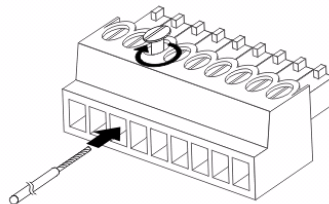

3. Insert the wired RS-422 connector back to the camera. Now the connection is completed

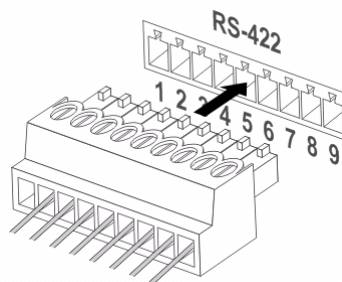

<Note> When RS-422 connection is being used, do not use RS-232C connection.

Chapter 9 Troubleshooting

This chapter describes problems you may encounter while using VC-A50PN. If you have questions, please refer to related chapters and follow all the suggested solutions. If the problem still occurred, please contact your distributor or the service center.

No.	Problems	Solutions
1.	Boot without power signal	<ol style="list-style-type: none"> 1. Make sure you have plugged in the power cord. 2. Make sure the Service DIP switch is Off. 3. Make sure that the terminal point is a hub that supports IEEE 802.3at when connecting via PoE.
2.	There is no image output from VC-A50PN	<ol style="list-style-type: none"> 1. Check the power. 2. Check if DIP switch is properly set. Please refer to Chapter 8 DIP Switch Setting for related settings. 3. Make sure the display supports the output resolution; in general, the resolution is 1080p60/1080i60/720p60. 4. Replace the cables and make sure they are not faulty.
3.	VC-A50PN image is severely delayed	Please use 1080p or 720p 60/50 Hz signals rather than 25/30 Hz signals.
4.	Not working after changes to DIP Switch setting	After completing DIP Switch setting, unplug and reconnect the power cord and turn on the machine to change the setting.
5.	VC-A50PN cannot be operated by remote control	<ol style="list-style-type: none"> 1. Please confirm if the Camera Select on the remote control can be used together with the IR Select on VC-A50PN. 2. Please prevent VC-A50PN from direct sunshine. 3. Make sure the energy-saving bulb and the IR touch screen are as far as possible in order to avoid interference. 4. When several VC-A50PN are connected in the same area, the operation of two remote controls at the same time may result in signal interference. It is recommended to use one remote control only.
6.	The device cannot be controlled with Codec	<ol style="list-style-type: none"> 1. Please consult the distributor to make sure the firmware version is the latest one. The steps to check version is as follows: <ol style="list-style-type: none"> 1.1 Press [MENU] on the remote control 1.2 Choose [Status] 1.3 Go to Page 5 of [System] 1.4 Make sure the firmware version is correct. 2. Make sure the connection is correct (RS-232/422 Input). 3. Make sure System Switch DIP 1 and DIP 3 are correct.
7.	The device cannot be controlled with RS-232/RS422	<ol style="list-style-type: none"> 1. Make sure the connection is correct (RS-232/422 Input). 2. Make sure System Switch DIP 1 and DIP 3 are correct.
8.	Whether the Internet can be used for operation	Please refer to Chapter 7 Network Function Description for the Internet usage

Supplier's Declaration of Conformity 47 CFR § 2.1077 Compliance Information

Manufacturer : Lumens Digital Optics Inc.

Product Name : VC-A50PN

Model Number : PTZ Video Camera

Responsible Party – U.S. Contact Information

Supplier : Lumens Integration, Inc.

4116 Clipper Court, Fremont, CA 94538, United States

e-mail : support@mylumens.com

FCC Compliance Statement

This device complies with Part 15 of the FCC Rules. Operation is subject to the following two conditions : (1) This device may not cause harmful interference, and (2) this device must accept any interference received, including interference that may cause undesired operation.